



Mirplay[®]
school

New Edition
2024



The school that I want

By listening to what the school you imagine is like,
we can offer you the furniture you need.

A school with comfortable, versatile furniture that supports
the different educational dynamics that take place in it and
that absorbs the use and pace of the students. Beautiful, solid
and mobile furniture aligned with today's pedagogies.

We are your partner in furniture to create the school you want.

Escuchando cómo es la escuela que imaginas
podemos ofrecerte los muebles que necesitas.

Una escuela con muebles confortables, versátiles, que dan apoyo
a las diferentes dinámicas educativas que en ella se desarrollan
y absorben el uso y el ritmo de los alumnos. Muebles bonitos,
sólidos y móviles alineados con las pedagogías de hoy.

Somos tu partner de mobiliario para crear la escuela que tú quieres.

Who are we?

We are a team with a family tradition and an international spirit that helps schools, high schools and universities around the world to improve their learning spaces.

Providing solutions that create versatile spaces, in which the student is the centre and learning expands, is what drives us.

Somos un equipo con ADN familiar y espíritu internacional que ayuda a las escuelas, institutos y universidades del mundo a mejorar sus espacios de aprendizaje.

Dar soluciones que creen espacios versátiles, en los que el alumno es el centro y el aprendizaje se expanda, es nuestro motor.





CLASSROOM DESIGN
DISEÑO DE AULAS



FAST DELIVERY
ENTREGA RÁPIDA



AFFORDABLE PRICES
PRECIOS ASEQUIBLES



INNOVATIVE PROPOSALS
PROPUESTAS INNOVADORAS



QUALITY MATERIALS
MATERIALES DE CALIDAD



CERTIFICATIONS
CERTIFICACIONES



PERSONALIZED ATTENTION
ATENCIÓN PERSONALIZADA





Colour for learning

The new line of furniture for learning features a colour palette inspired by nature. Colours of the sea, land and sky harmonize the design and offer a calm and comfortable beauty that responds to an expanding trend in the school sector.

La nueva línea de muebles para el aprendizaje presenta una paleta de colores inspirada en la naturaleza. Cromatismos del mar, la tierra y el cielo armonizan el diseño y ofrecen una belleza calmada y confortable que da respuesta a una tendencia en expansión del sector escolar.

LIGHT GREY

A neutral and balanced colour. Light grey is associated with conservative and sophisticated meanings.

Un color neutro y equilibrado. El gris claro se asocia a opciones conservadoras y sofisticadas.



TERRACOTA

It's not a single colour, but a family of colours that resemble fired clay. It means "fired earth" and the component colours are typically orange and brown.

No se trata de un solo color, sino de una familia de colores que recuerdan la arcilla cocida. Significa "tierra cocida" y los colores que la componen son habitualmente naranja y marrón.

OCRE

Possibly one of the oldest colours and a symbol of life. Some societies quite often associate it with life.

Posiblemente uno de los colores más antiguos y un símbolo vital. Algunas sociedades lo asocian habitualmente con la vida.



MINT

A freshening and welcoming hue associated with summer and water activities because of its similarity to sea shades and pools. It represents tranquillity, balance and calm.

Tonalidad refrescante y acogedora asociada a las actividades de verano y acuáticas por su similitud con las sombras del mar y las piscinas. Representa tranquilidad, equilibrio y calma.

NAVY

Chromatic harmony is the equilibrium that one obtains when the right colours are combined. It is consonance, it is calm, it is a piano perfectly in tune.

La armonía cromática es el equilibrio que se obtiene cuando se combinan los colores adecuados. Es consonancia, es calma, es un piano perfectamente afinado.

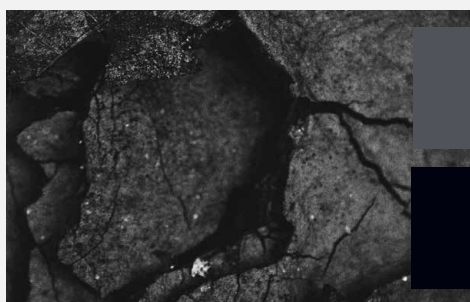

CHARCOAL

It has a great expressive value: highlights the forms, making them more elegant and sophisticated. It's the colour that combines in perfect harmony with all the others.

Tiene un gran valor expresivo: resalta las formas, haciéndolas más elegantes y sofisticadas. Es el color que combina en perfecta armonía con todos los demás.

Index

Learning
spaces

10



S.T.E.A.M.

32



Technology

40



Teacher's
space

48



Multipurpose spaces

56

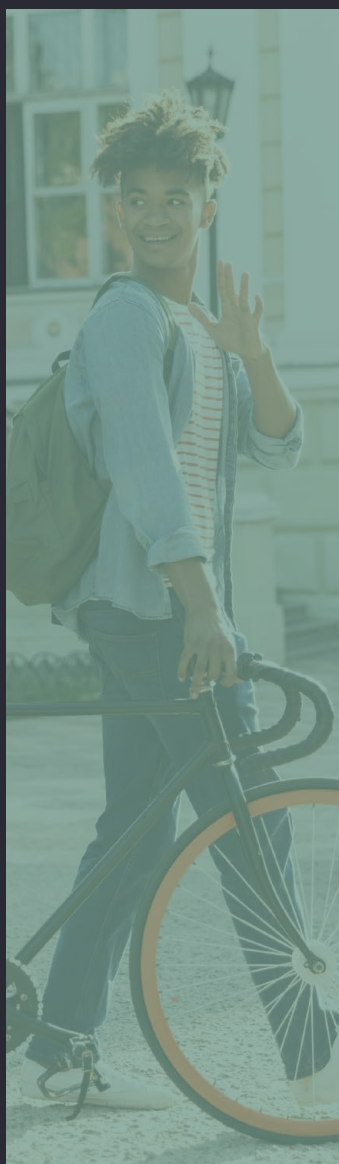

Canteen

66



Early ages

74

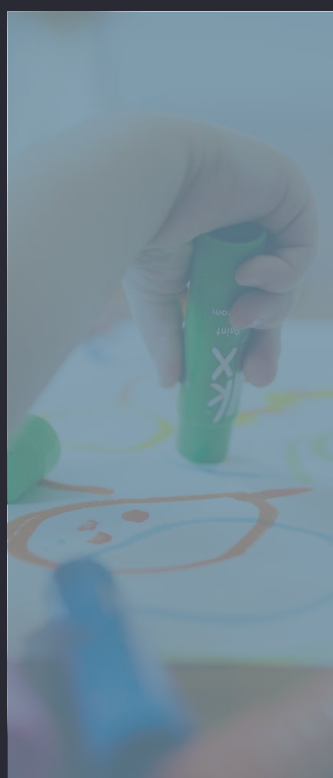

CHAIRS

92



SOFT SEATING

110



TABLES

118



ACOUSTIC

148



CABINETS

156

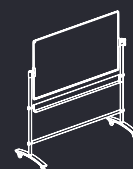

COMPLEMENTS

178



Learning spaces

Discovering, organizing and transforming our world is exciting, stimulating and a daily challenge we can make a reality in any space.

How can we create diverse learning spaces?

Descubrir, organizar y transformar el mundo que nos rodea es estimulante, apasionante y un desafío diario que podemos hacer que ocurra en cualquier espacio.

¿Cómo crear espacios de aprendizaje diversos?



LEARNING SPACES

The joy of growing and expanding



The school is that friendly and safe space where understanding, creativity and feelings allow to discover both the world and oneself.

La escuela es el espacio amigable y seguro en el que la comprensión, la creatividad y el sentir permiten descubrir tanto el mundo como a uno mismo.



Dividing is adding.







Separating areas within the same space is easy with panels that also provide acoustic comfort. The learning environment has a deep impact on the educational results of all students. Shall we make the most of every square meter?

Separar zonas en un mismo espacio es fácil con los paneles que además aportan confort acústico. El entorno de aprendizaje tiene un efecto profundo en los resultados educativos de todos los alumnos, ¿le sacamos partido a cada metro cuadrado?



54 m²



30





HEXA

The HEXA table is the paradigm of versatility and storage optimization.

La mesa HEXA es el paradigma de la versatilidad y la optimización en su almacenaje



SAMOS

SAMOS acoustic panels divide spaces and dampen sound, making communication easier.

Los paneles acústicos SAMOS, separan espacios y amortiguan el sonido facilitando la comunicación.



MIA LIFT

Ergonomic MIA chairs favour the natural movement of the body. With padded seat option for extra comfort.

Las sillas ergonómicas MIA facilitan el movimiento natural de cuerpo. Con opción de tapizado para mayor confort.



Learning in motion.



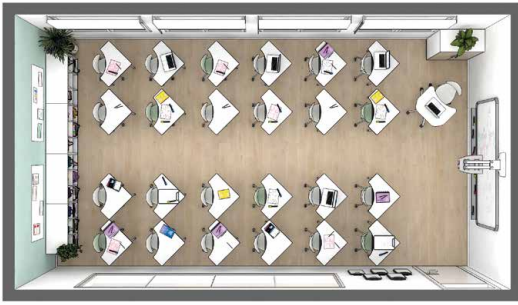

The learning experience needs guidance, but also freedom. Freedom of movement to create and dismantle work groups with versatile tables. Spaces bringing about learning with order and good acoustics to facilitate communication and comfort.

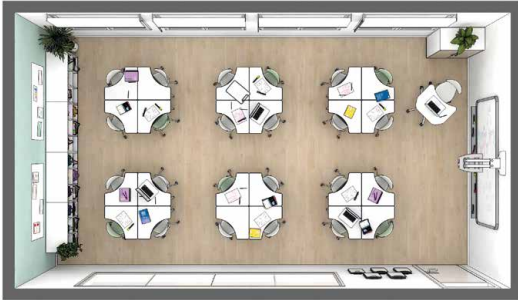

La experiencia del aprendizaje necesita guía, pero también libertad. Libertad de movimiento para agruparse y desagruparse por equipos de trabajo con mesas versátiles. Espacios que sean catalizadores del conocimiento con orden, buena acústica para facilitar la comunicación, comodidad y confort.

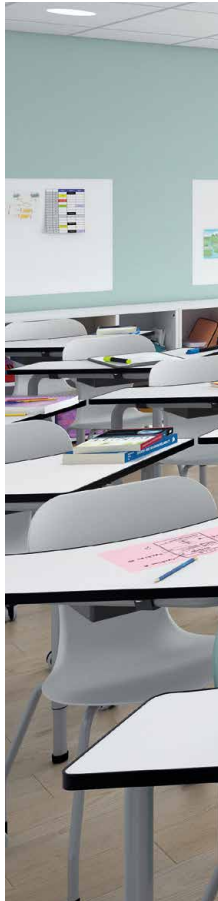

45 m²



24





The MINI LILY individual whiteboard and its storage system promote order and debate in the classroom.

La pizarra individual MINI LILY y su sistema de almacenaje facilitan el debate y el orden en el aula

MINI LILY



The MOON table, adjustable in height, provides teachers with the position within the group that they need at all times.

La mesa MOON, regulable en altura, proporciona al profesorado la posición dentro del grupo que necesita en cada momento.

MOON







*Small changes,
big improvements.*

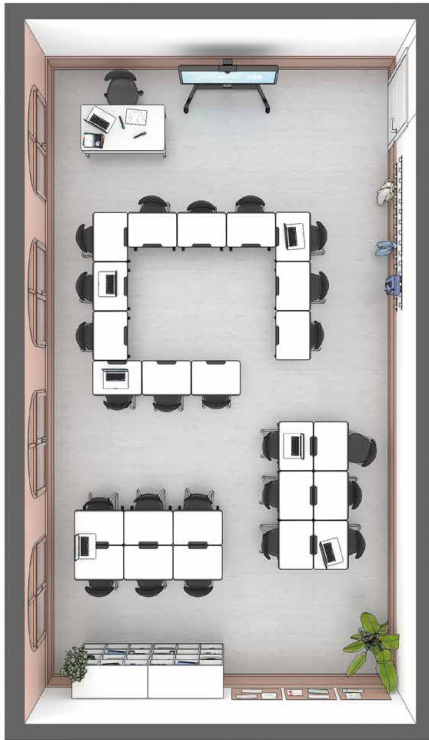

Sometimes, it all comes down to having the ideal chairs and desks to improve concentration, order and comfort, and just letting space and natural light do the rest.

A veces solo es necesario contar con los pupitres y las sillas idóneas para ganar en concentración, orden y confort y dejar que el espacio y la luz natural hagan el resto.



45 m²



24





RECTANGLE TEACHER

The classical teacher's desk with drawer and modesty panel is called RECTANGLE TEACHER.

La clásica mesa para profesorado con cajón y faldón se llama RECTANGLE TEACHER.



MIA CANTILEVER

The MIA CANTILEVER chair helps to optimize cleanliness and order in classrooms.

La silla MIA CANTILEVER ayuda a optimizar la limpieza y el orden en las aulas.

*Welcome to the
superclassroom.*







In multi-purpose spaces with multiple dynamics, the Teaching-how-to-Learn paradigm shift shines. In these areas, the organization of space, time and materials is key to facilitating synergies.

En los espacios polivalentes de múltiples dinámicas es donde brilla el cambio de paradigma de enseñar a aprender. En ellos la organización del espacio, del tiempo y de los materiales es clave para facilitar sinergias.



150 m²



60





MIA TABLE

MIA TABLE chairs with folding table and lower storage tray to easily form and dismantle groups.

Sillas con pala y almacenaje MIA TABLE para agruparse y desagruparse fácilmente.



MIA STORE

Large work tables and MIA STORE chairs with a storage tray so that dynamism in the super classroom does not mean clutter.

Mesas amplias de trabajo y sillas MIA STORE con bandeja para almacenaje para que el dinamismo en la súperaula no altere su orden.

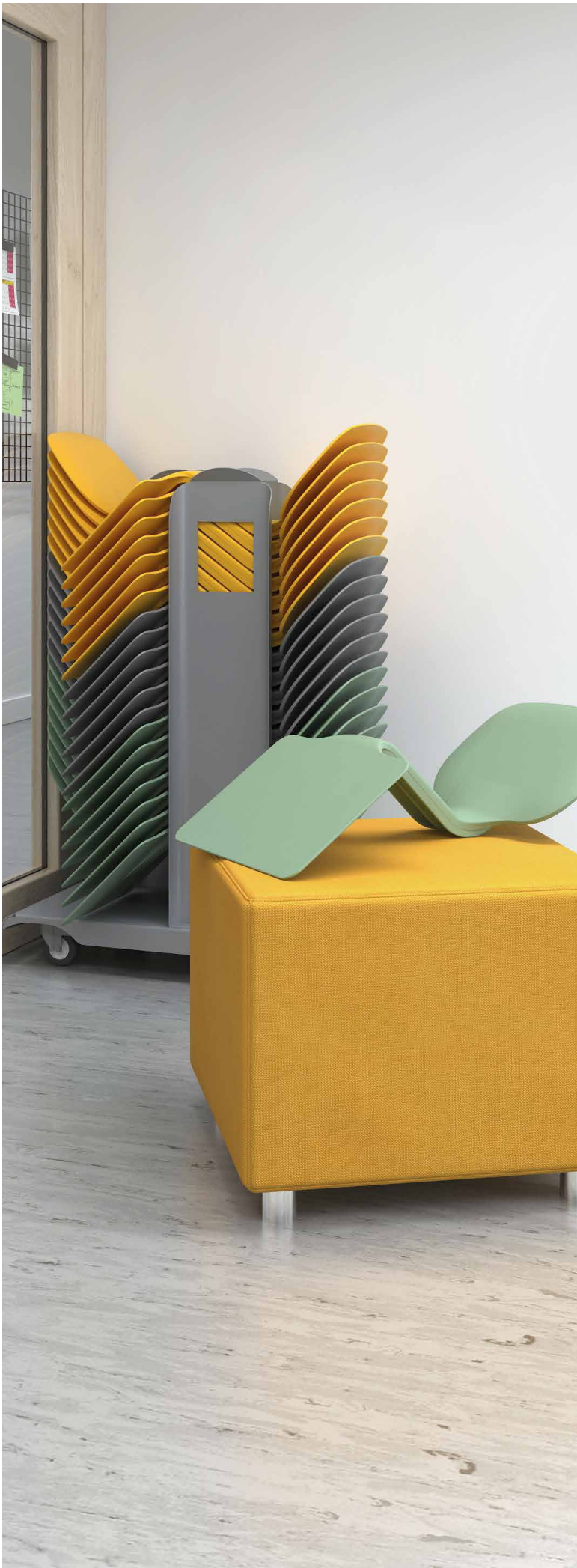

Marga Tubau

Sales Manager

What can make
neurons dance?

A strategically placed sofa.
A panel that turns into a
mobile whiteboard. Let the
desire to learn, share ideas
and contrast them find
their space in any corner.

¿Qué puede hacer que
las neuronas bailen?

Un sofá estratégicamente
ubicado. Un panel que
es una pizarra móvil.
Hagamos que las ganas de
aprender, compartir ideas y
contrastarlas encuentren su
espacio en cualquier rincón.

Tips for corners



A passage area or a corner of 3m² allows a one-on-one meeting.

Una zona de paso o un rincón de 3m² da lugar a una reunión de tú a tú

The combination of grades in different sizes creates a facilitating space for meetings and discussions.

La combinación de gradas de diferentes dimensiones crea el espacio facilitador para el fórum o el debate



Create a discussion area in a classroom: it just takes a sofa, a whiteboard and an acoustic divider.

Crear una zona de debate en un aula: este rincón solo necesita un sofá, una pizarra y divisor acústico

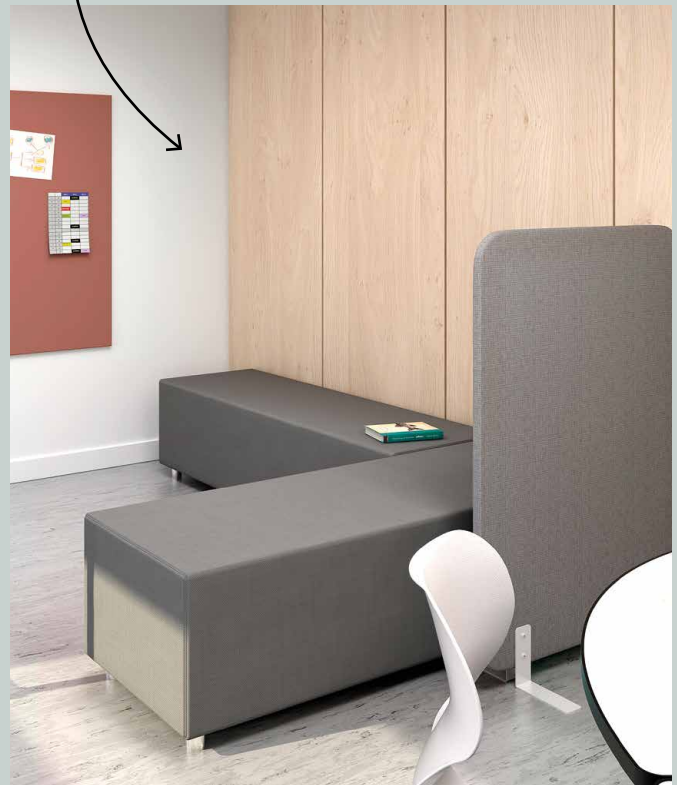

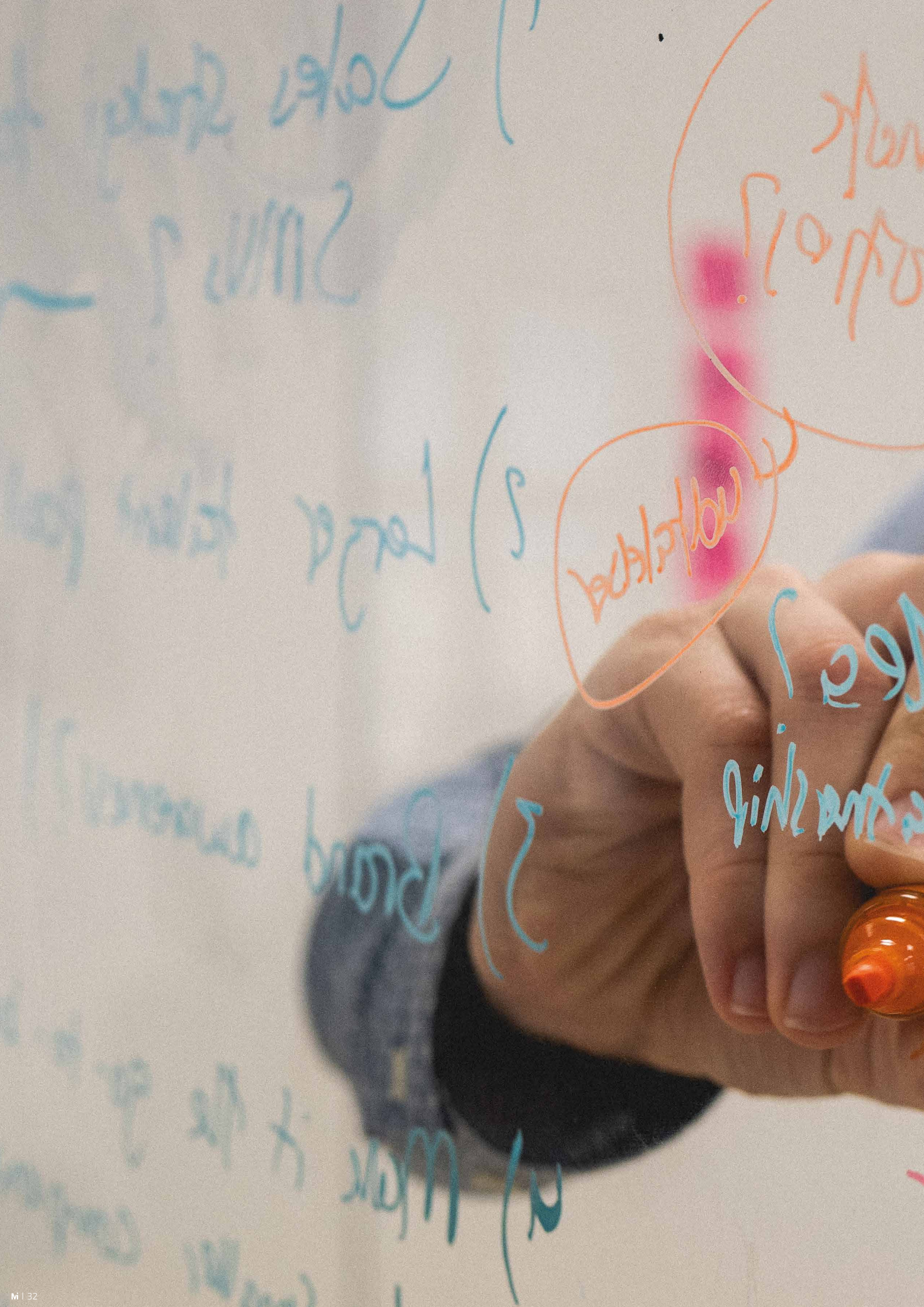

rehabilitation

1) Take steps

2) ...

3) ...

4) ...

5) ...

rehabilitation

rehabilitation



S.T.E.A.M.

*Science. Technology.
Engineering. [Arts]. Maths.*

Transversal and multidisciplinary learning enhances the capacity for research, exploration, problem solving and curiosity. Learn by combining various fields of knowledge in the same space.

How to create STEAM learning classrooms?

El aprendizaje transversal y multidisciplinar potencia la capacidad de investigación, exploración, resolución de problemas y la curiosidad. Aprender conjugando diversos ámbitos de conocimiento en un mismo espacio.

¿Cómo crear aulas de aprendizaje STEAM?



S.T.E.A.M.

Classrooms with space for everything

The desire to learn is the engine for knowledge and an endless source of personal satisfaction. Stimulating spaces have to be created.

A classroom where the teacher can play different roles and students can perform different activities at the same time?

Las ganas de saber son el motor del conocimiento y una inagotable fuente de satisfacción personal. Hay que crear espacios que las estimulen.

¿Un aula donde el docente puede ejercer diferentes roles y los alumnos desarrollar distintas actividades a la vez?

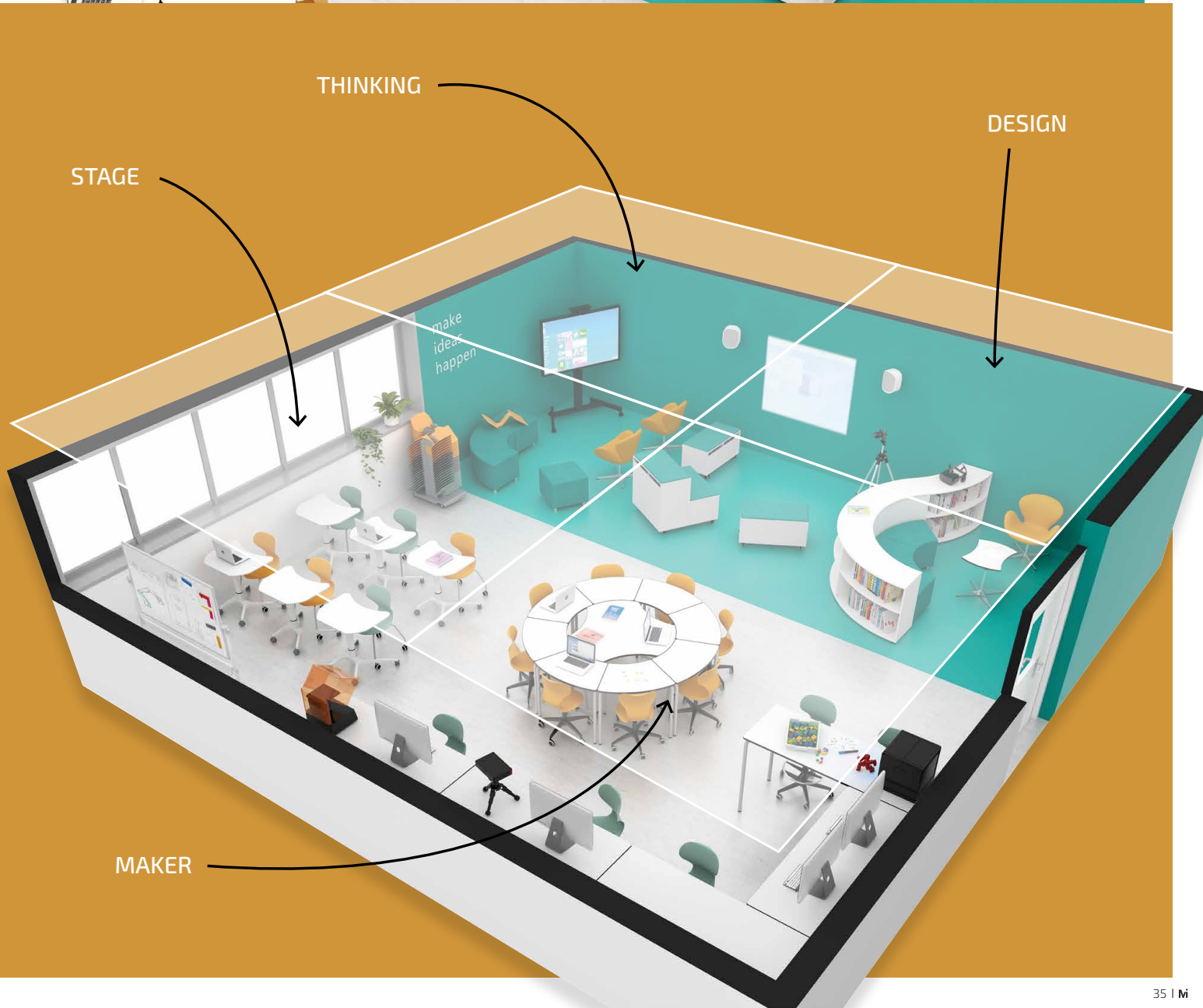

*The same stage
multiple spaces*



make
ideas
happen



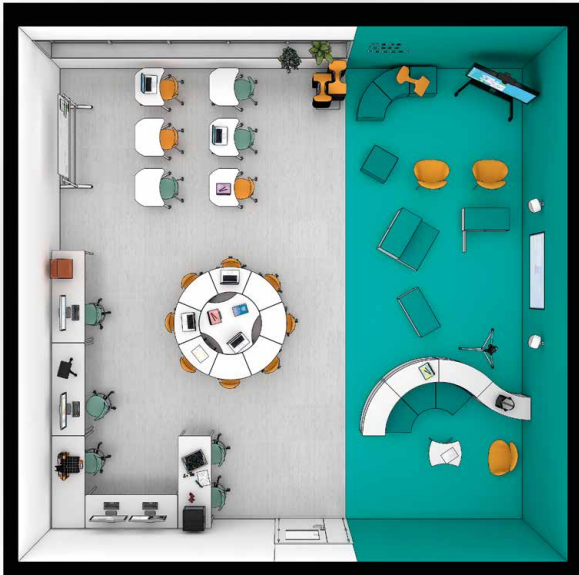

A multidirectional space with zones to carry out different activities related to the same project not only optimizes time and space, but it also fosters concentration and cooperative work.

The goal is to create spaces that are allied with knowledge. Shall we do it?

Un espacio multidireccional con diferentes zonas para diversas actividades relacionadas con la ejecución de un mismo proyecto no solo optimiza tiempo y espacio, también estimula la concentración y el trabajo cooperativo.

El objetivo es crear ambientes que se alíen con el conocimiento. ¿Lo hacemos?



87 m²



40





MOVE

MINI MOVE

MOVE and MINI MOVE grades create a forum area for exhibitions and debates.

Las gradas MOVE y MINI MOVE crean una zona forum para la exposición y el debate.



OCTA

TRISIX

OCTA and TRISIX tables allow you to quickly create work groups, providing a design zone when needed.

Las mesas OCTA y TRISIX permiten crear ágilmente grupos de trabajo facilitando una zona design cuando se necesita.



Tech —nology

The technological ecosystem is part of the life of 21st century students. They are protagonists and will be the creators of the technology we use on a daily basis. Programming, ICT and robotics have their own space.

How to foster technological learning?

El ecosistema tecnológico forma parte de la vida de los estudiantes del siglo XXI. Ellos son protagonistas y serán los creadores de la tecnología que utilizamos en el día a día. La programación, las TIC y la robótica tienen su propio espacio.

¿Cómo facilitar el aprendizaje tecnológico?

TECHNOLOGY

Technology is the way, not the message.

By programming, students improve their ICT knowledge and they also learn to work in groups, negotiate, be assertive, manage frustration, present ideas, gain efficiency, security, analytical skills and a large number of necessary abilities in the current and future work environment.

Programando los alumnos mejoran en conocimientos TIC, pero también aprenden a trabajar en grupo, negociar, ser asertivos, gestionar la frustración, presentar ideas, ganar en eficiencia, seguridad y capacidad de análisis y un gran número de habilidades necesarias en panorama laboral del presente y del futuro.





Periodic Table of Elements

| Group | 1 | 2 | 3 | 4 | 5 | 6 | 7 | 8 | 9 | 10 | 11 | 12 | 13 | 14 | 15 | 16 | 17 | 18 | | | |
|-------|---|----|----|----|----|----|----|----|----|----|----|----|----|----|----|----|----|----|----|----|----|
| 1 | H | He | | | | | | | | | | | | Li | Be | B | C | N | O | F | Ne |
| 2 | | | Na | Mg | Al | Si | P | S | Cl | Ar | | | | | | | | | | | |
| 3 | | | K | Ca | Sc | Ti | V | Cr | Mn | Fe | Co | Ni | Cu | Zn | Ga | Ge | As | Se | Br | Kr | |
| 4 | | | Rb | Sr | Y | Zr | Nb | Mo | Tc | Ru | Rh | Pd | Ag | Cd | In | Sn | Sb | Te | I | Xe | |
| 5 | | | Cs | Ba | La | Hf | Ta | W | Re | Os | Ir | Pt | Au | Hg | Tl | Pb | Bi | Po | At | Rn | |
| 6 | | | Fr | Ra | Ce | Pr | Nd | Pm | Sm | Eu | Gd | Tb | Dy | Ho | Er | Tm | Yb | Lu | | | |
| 7 | | | | | Ac | Th | Pa | U | Np | Pu | Am | Cm | Bk | Cf | Es | Fm | Md | Nd | | | |

Ideas lab.





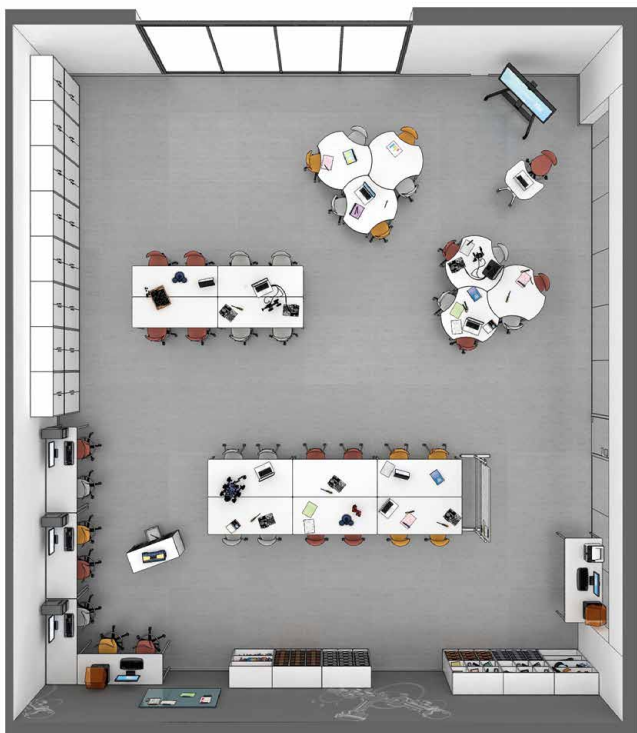

Design contributes to making the educational experience more effective, pleasant and fulfilling in the technology classroom.

Freedom of movement is key here for an agile manipulation of the object of study and the possibility of grouping in small work teams. Whiteboards and mobile auxiliary furniture allow the sharing of ideas and materials

El diseño contribuye a hacer la experiencia educativa más eficaz, placentera y plena en el aula tecnológica.

Aquí la libertad de movimiento para la ágil manipulación del objeto de estudio y la opción de agruparse en equipos de trabajo reducidos es clave. Las pizarras y los muebles auxiliares móviles permiten compartir ideas y materiales.



150 m²



45





MIA STOOL

RECTANGLE PLUS

High and spacious tables, ideal for teamwork and ergonomic stools.
RECTANGLE PLUS table and MIA stools.

Mesas altas y espaciosas, idóneas para trabajar en equipo y taburetes ergonómicos.
Mesa RECTANGLE PLUS y taburete MIA STOOL



TRISIX

Versatile and easy to fit tables to form and dismantle work teams.

Mesas versátiles y fácilmente almacenables para agrupar y desagrupar equipos de trabajo.



Teacher's space

The engine and heart of the school are the teaching team. Teachers need a space to rest, relax and at the same time work as a team, talk and continue promoting education today and tomorrow.

How do you imagine the staff room?

El motor y corazón de la escuela son el equipo docente. El profesorado necesita un espacio para descansar, relajarse y a la vez trabajar en equipo, conversar y seguir impulsando la educación de hoy y mañana.

¿Cómo imaginas la sala de profesores?

TEACHER'S SPACE

Creators of learning experiences

If the teacher is the designer of the learning experience, the educational space is the setting that inspires it.

Si el docente es el diseñador de la experiencia de aprendizaje, el espacio educativo es el escenario que la inspira.

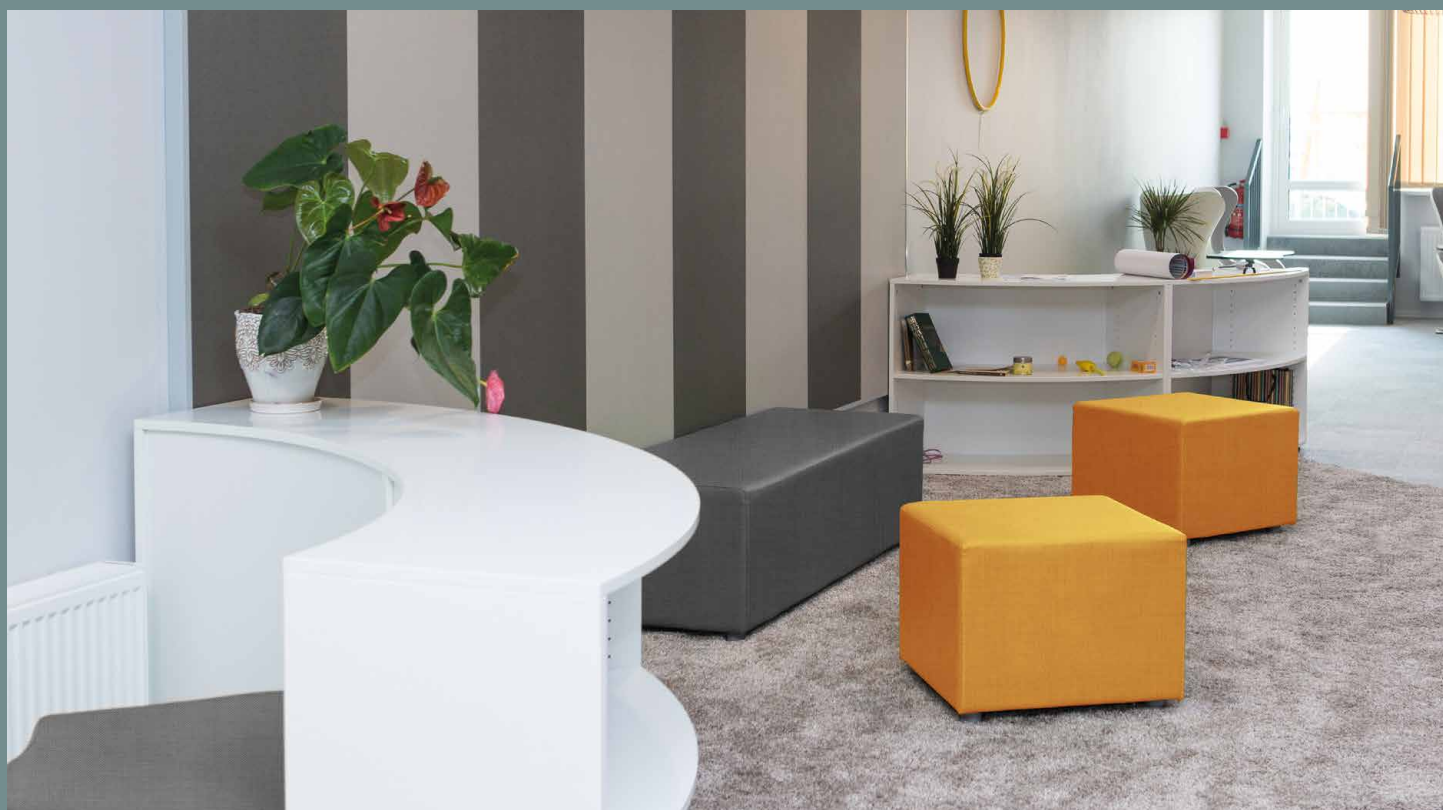



A small oasis.





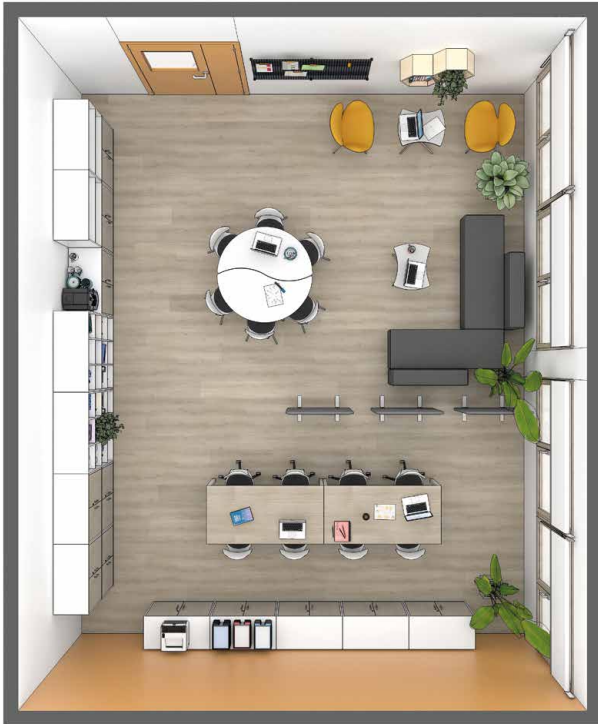

The place for reflection, assessment, content preparation and rest. The space for interaction between co-workers and meetings between tutors and students.

El lugar para la reflexión, la evaluación, la preparación de contenidos y el descanso. El espacio para la interacción entre compañeros de trabajo y las reuniones entre tutores y alumno.



50 m²



22





SAMOS

SAMOS dividers separate and isolate acoustically.

Los divisores SAMOS separan y aíslan acústicamente

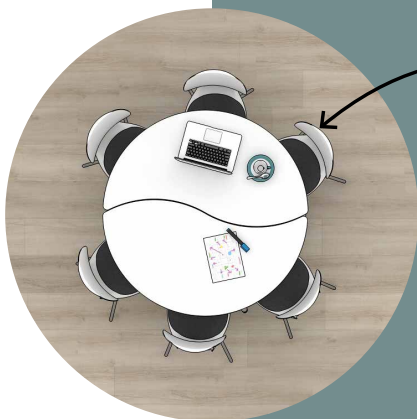

YANG

YANG tables to close the circle.

Mesas YANG para una mesa redonda



The background of the page is a photograph of a building facade with light-colored stone or brickwork. In the bottom left corner, the front wheel of a bicycle with a bright orange rim is visible. The text is overlaid on a dark teal rectangular area.

Multi — purpose spaces

Spaces are constantly evolving and many of them are transformed and inhabited in multiple ways. The diversity of activities gives way to the versatility, movement and multiple uses of furniture.

How to create multifunctional spaces?

Los espacios están en constante evolución y muchos de ellos se transforman y se habitan de múltiples formas. La diversidad de actividades abre paso a la versatilidad, el movimiento y los múltiples usos del mobiliario.

¿Cómo crear espacios multifuncionales?

MULTIPURPOSE SPACES

Libraries shout: **Come!**

Libraries go from being a place where people just do research to become a place to go to feel more productive or to be close to friends and colleagues.

They become interdisciplinary, inclusive and inspiring learning spaces.

Las bibliotecas pasan de ser un lugar al que las personas van solo para investigar a un lugar que eligen visitar porque se sienten más productivos o quieren estar cerca de amigos y colegas.

Se convierten en espacios de aprendizaje interdisciplinarios, inclusivos e inspiradores.





Wellness feeling.







Libraries are at the intersection of academic, social and emotional needs. They become a meeting place where students can grow in many aspects.

Las bibliotecas se encuentran en la intersección de las necesidades académicas, sociales y emocionales. Se convierten en lugar de reunión donde los estudiantes pueden desarrollarse en múltiples dimensiones.



220 m²



75





Areas to sit and read as you would at home. Set of armchair and low table.

CHARLOTTE

Zonas para sentarse a leer como lo harías en casa. Conjunto de butacas y mesa baja.

LOUISE



Furniture with organic shapes that allows dividing spaces and create a comfort zone with sofas.

MARIE

Mobiliario de formas orgánicas que permite delimitar espacios y crear zona de confort con sofás.





Joan Jalencas

Sales Manager

Get together, meet, concentrate, explain, experiment, share, listen actively, etc., in different areas within the same educational, with versatile and mobile furniture, as well equipped as the mind is when learning.

Agruparse, reunirse, concentrarse, explicarse, experimentar, compartir, escuchar activamente... en un mismo espacio educativo con zonas diferenciadas, bien equipadas con mobiliario versátil y móvil. Tanto como lo es la mente cuando aprende.

Tips for corners



The MARIE curved cabinet surrounds an space that, together with the ANGLE sofa, invites to meet in small groups to debate.

El armario en curva MARIE recoge un espacio que con el sofá ANGLE invita a reunirse en pequeños grupos para debatir.

The double-height MARIE curved cabinet creates an interior space that enables a quiet work area with a large table.

El armario en curva MARIE en doble altura crea un espacio interior que habilita una zona de trabajo tranquila con una amplia mesa.



The CHARLOTTE armchair, with its wraparound seat, leads to internalisation, calm and meditation.

La butaca CHARLOTTE, asiento envolvente, conduce a la interiorización, la calma y la meditación.







Canteen

Educate, socialize and rest in the canteen
to nurture students and teachers.

Each age has specific needs and creating a pleasant and
calm atmosphere around the table is the starting point.

How to create canteens that nurture learning?

Educar, socializar y descansar desde el comedor
para nutrir a alumnos y profesorado.

Cada edad tiene unas necesidades concretas y
crear un entorno agradable y tranquilo alrededor
de la mesa es el punto de partida.

¿Cómo crear cantinas que alimenten el aprendizaje?

CANTEEN

Much more than eating

Eating is a basic need. So are socializing, enjoying, savouring, learning, sharing, relaxing and nourishing oneself internally and externally.

Alimentarse es una necesidad. Socializar, disfrutar, saborear, aprender, compartir, descansar y nutrirse por dentro y por fuera, también.





Meeting point.







As at home, where kitchen becomes the nerve centre where life happens, we can turn the canteen into something more than just a place to eat. The wood finishes, the organic colors and the design aiming to offer comfort are the key.

Como ocurre en un hogar, donde la cocina acaba siendo el punto neurálgico donde se desarrolla la vida, podemos conseguir que la cantina se habite para mucho más que para solo comer. Los acabados de madera, los colores orgánicos y el diseño pensado para ofrecer confort y comodidad, son la clave.



108 m²



48





INA

The INA chair is stackable, easy to clean and maintain.

La silla INA es apilable, fácil de mantener y limpiar.



IRENE

The IRENE cabinet with its wooden doors brings warmth to the canteen and helps keep the space tidy and clean.

El armario IRENE con sus puertas de madera aporta calidez al comedor y ayuda a mantener el espacio ordenado y limpio.





Early ages

Feeling safe playing, experimenting calmly, surrounded by beauty and order. Spaces where the little ones are the protagonists offer comfort and security to imagine, create and grow freely.

How to create learning spaces that promote calm?

Sentirse seguro jugando, experimentar con calma, rodeado de belleza y orden. Los espacios donde los más pequeños son los protagonistas ofrecen confort y seguridad para imaginar, crear y crecer libremente.

¿Cómo crear espacios de aprendizaje que promuevan la calma?

EARLY AGES

Sensory experimentation

A classroom with different corners where symbolic play can be developed and sensory stimulation favored by manipulating different objects that are the center of interest for the little ones.

Un aula con diferentes rincones donde desarrollar el juego simbólico y favorecer la estimulación sensorial con la manipulación de diferentes objetos que son centro de interés de los más pequeños.





The living classroom.





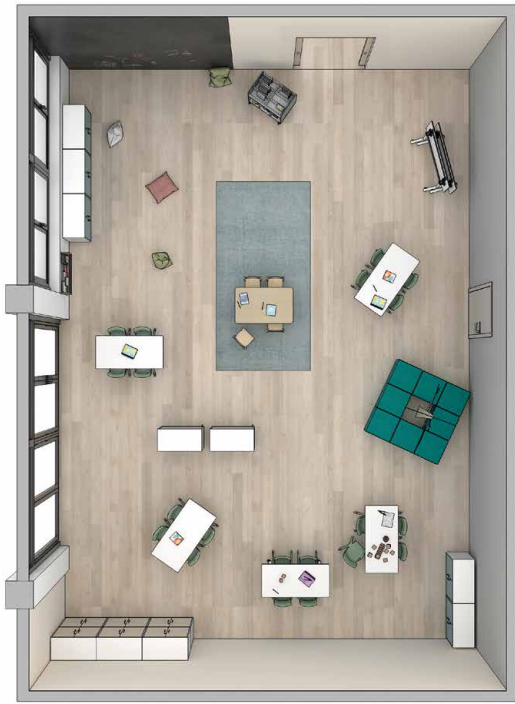

Classrooms where different educational dynamics coexist simultaneously, where the little ones move, group and ungroup to experiment, rest, play.

Aulas en las que conviven simultáneamente diferentes dinámicas educativas, donde los más pequeños se mueven, agrupan y desagrupan para experimentar, descansar, jugar.



100 m²



25





TEO

The wood in tables (TEO) and chairs (ZOE) brings warmth and comfort to the classroom.

La madera en mesas (TEO) y sillas (ZOE) aporta calidez y confort al aula.

ZOE



HEDY

The HEDY cabinet on castors allows you to comfortably and dynamically separate spaces.

El armario con ruedas HEDY permite separar espacios cómodamente y de forma dinámica.

MINIFLOOP

The MINIFLOOP tables are folding and allow you to quickly transform a workspace into an open space to play or rest.

Las mesas MINIFLOOP son abatibles y permiten transformar rápidamente un espacio de trabajo en uno diáfano para jugar o descansar.



*Montessori-inspired
classroom.*





A modular classroom in which cooperative work is the core and the child the protagonist of their experience and learning. With tables that allow various configurations to expand the multiple intelligences.

Un aula modular en la que el trabajo cooperativo es el eje y el niño el protagonista de su experiencia y aprendizaje. Con mesas que permiten diversas configuraciones donde expandir las múltiples inteligencias.



40 m²



25





MIA MINILIFT

The MIA MINILIFT chair for adults adapts to the height of children's tables for greater comfort for teachers and students.

La silla MIA MINILIFT para adulto se adapta a la altura de las mesas infantiles para un mayor confort de docentes y alumnos.

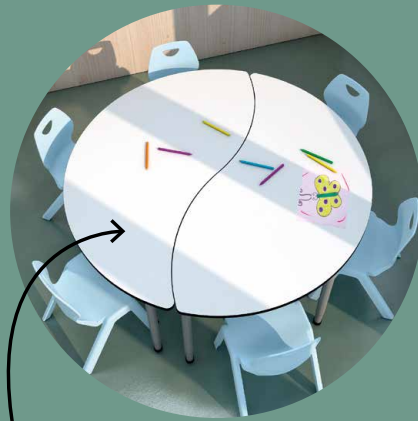

MIA MINILIFT

The YANG table allows you to quickly create round tables and also different configurations.

La mesa YANG permite crear mesas redondas y diferentes encajes ágilmente.



*The importance
of order.*





Storage in the classroom favors both spatial and mental order. Tables and cabinets that, with their design, colour and resistance to shocks and water, favor visual and experiential harmony in the classroom.

El almacenaje en el aula para disponer el material favorece el orden del espacio y el mental. Mesas y armarios que, con su diseño, cromatismo y resistencia a los golpes y al agua, favorecen la armonía visual y experiencial en el aula.



60 m²



25





GRACE

The GRACE cabinet with trays in two sizes, guided by rails to prevent them from coming out of the cabinet.

El armario GRACE con bandejas de dos tamaños, sujetas por railes para evitar que se salgan del mueble.

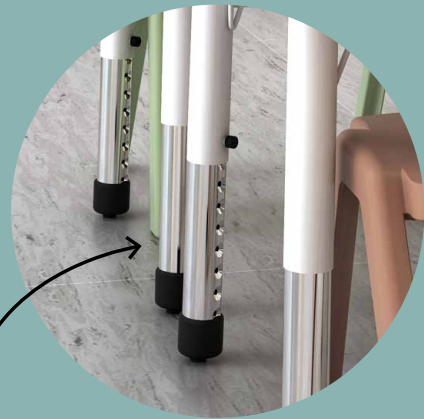

RONY

The RONY table has adjustable legs at different heights for the comfort of all.

La mesa RONY tiene las patas ajustables a diferentes alturas para comodidad de todos.

Furnishing spaces that furnish minds

This is our passion. We understand how students learn and how educators in the 21st century want to teach. As education keeps evolving, so do we.

Esta es nuestra pasión. Entendemos cómo aprenden los estudiantes y cómo quieren enseñar los docentes del siglo XXI. A medida que la educación continúe evolucionando, nosotros también.

CHAIRS

SILLAS

92



SOFT SEATING

SOFT SEATING

112



TABLES

MESAS

120



ACOUSTIC

ACÚSTICA

150

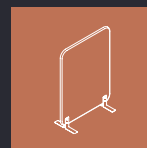

CABINETS

ARMARIOS

156



COMPLEMENTS

COMPLEMENTOS

178



Chairs

Reconcile with the movement.
Chairs that facilitate grouping and ungrouping quickly and without noise, that promote order and prioritize dynamic comfort. Chairs not only designed for sitting down.

Reconciliarse con el movimiento.
Sillas que facilitan el agruparse y desagruparse ágilmente y sin ruidos, que favorecen el orden y priorizan un confort dinámico. Sillas no solo pensadas para el momento de sentarse.





JON

Ref. 1045



60% Recycled Plastic



SIZE

(+info P. 193)

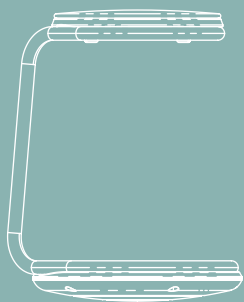

53,5 CM

7

DETAILS

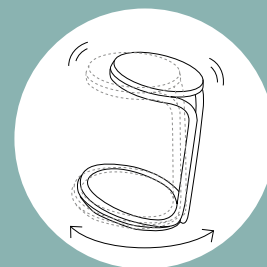

JON







MIA



60% Recycled Plastic

MIA BASIC



MIA CANTILEVER



MIA CASTORS



MIA MINI LIFT



MIA LIFT



MIA BIG LIFT



MIA STOOL



MIA STORE



MIA TABLE





MIA BASIC

Ref. 1028



SIZE

(+info P. 193)

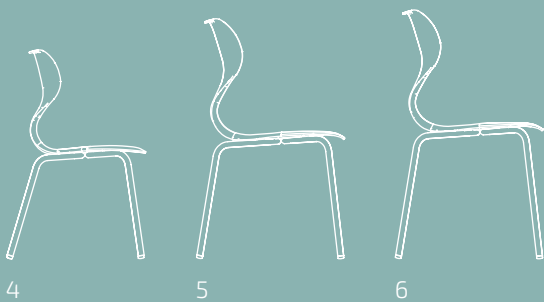

OPTIONS



DETAILS



MIA CANTILEVER

Ref. 1027



SIZE

(+info P. 193)



5



6

OPTIONS



DETAILS





MIA CASTORS

Ref. 1029



SIZE

(+info P. 193)



4



5



6

OPTIONS



DETAILS



MIA MINI LIFT

Ref. 169



OPTION Ref. 0129

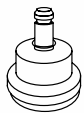

SIZE

(+info P. 193)

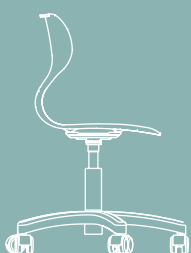

31-39,5 CM

DETAILS





MIA LIFT

Ref. 1035



OPTION Ref. 0129

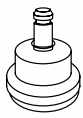

SIZE

(+info P. 193)

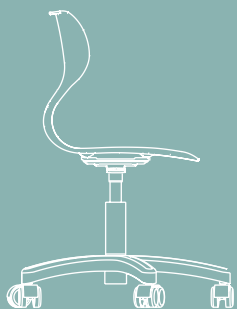

40-51 CM

OPTIONS



DETAILS



MIA BIG LIFT

Ref. 1039



OPTION Ref. 0129

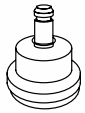

SIZE

(+info P. 193)

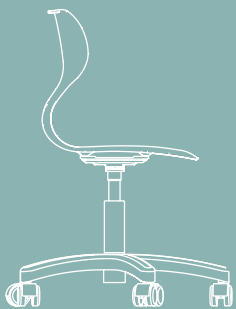

40-51 CM

OPTIONS



DETAILS





MIA STOOL

Ref. 1030



OPTION Ref. 0129

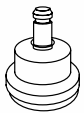

SIZE

(+info P. 193)

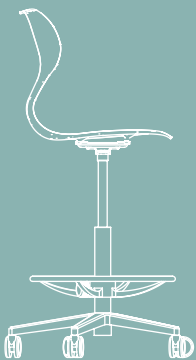

58-83 CM

OPTIONS



DETAILS



MIA STORE

Ref. 1038



SIZE

(+info P. 193)

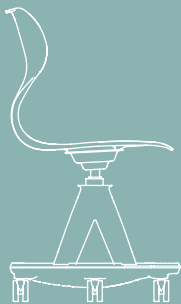

6

OPTIONS



DETAILS





MIA TABLE

Ref. 1036



SIZE

(+info P. 193)

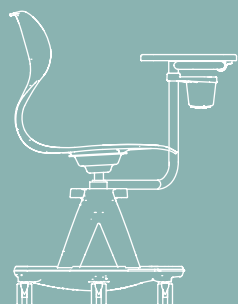

57X33 CM

6

OPTIONS



DETAILS





360°



How does it work? Watch the video here:
¿Cómo funciona? Mira el vídeo aquí:





ZTOOL

Ref. 1020



60% Recycled Plastic



ZTOOL TROLLEY

Ref. 1037



X 40 ZTOOL



YouTube



How does it work? Watch the video here:
¿Cómo funciona? Mira el vídeo aquí:



SIZE
(+info P. 193)

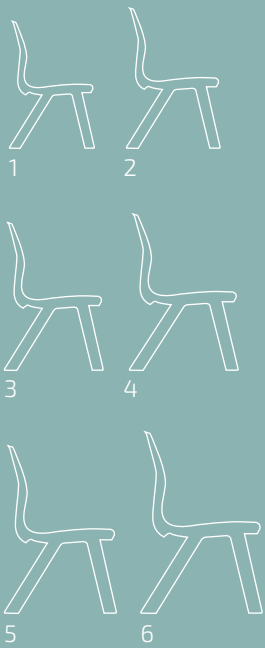

INA

Ref. 147



60% Recycled Plastic

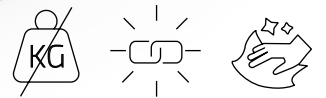

SIZE
(+info P. 193)

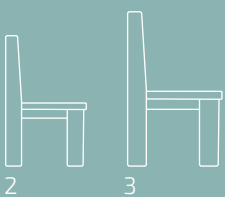

ZOE

Ref. 1044



DETAILS | DETALLES



Soft seating

Socialize, share and relax.
Soft seating furniture allows you to create a space for impromptu conversations and allows you to bring life to areas of the educational centre that have not been used until now.

Socializar, compartir y relajarse.
El mobiliario soft seating permite crear un espacio para conversaciones improvisadas y permite dar vida a zonas del centro educativo hasta ahora desaprovechadas.







CHLOE

Ref. CHLOE

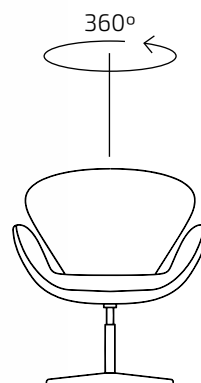

SIZE

69 CM

67 CM



79 CM

44 CM

DETAILS



CHARLOTTE

Ref. 1041

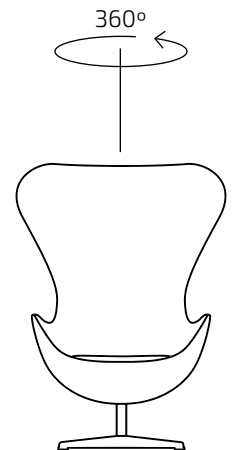

SIZE

82 CM

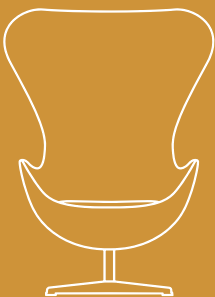

77 CM



108 CM

42 CM

DETAILS





ANGLE

Ref. 12001

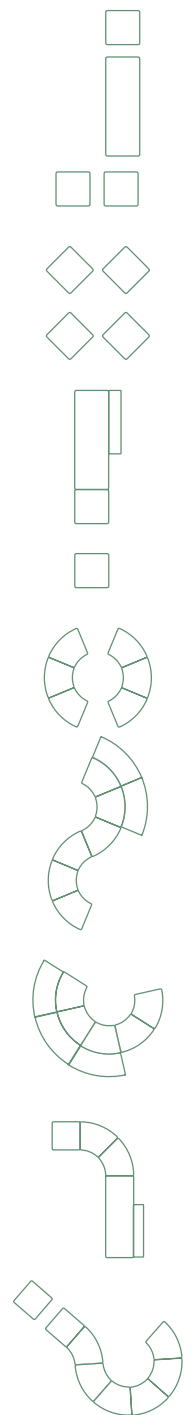

CUBE

Ref. 12002

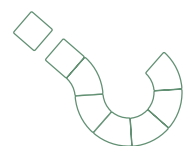

SIZE

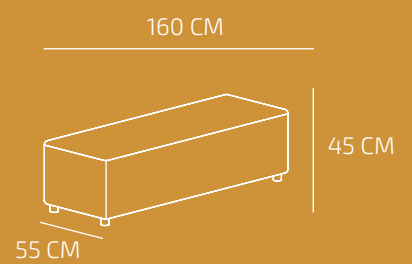
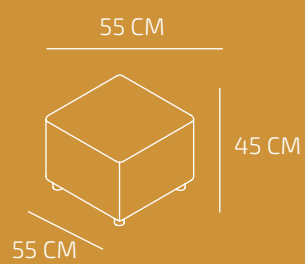
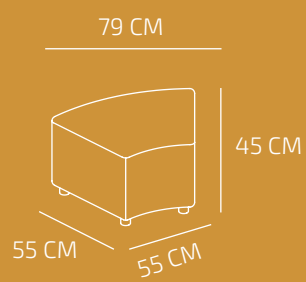



TUBE

Ref. 12003

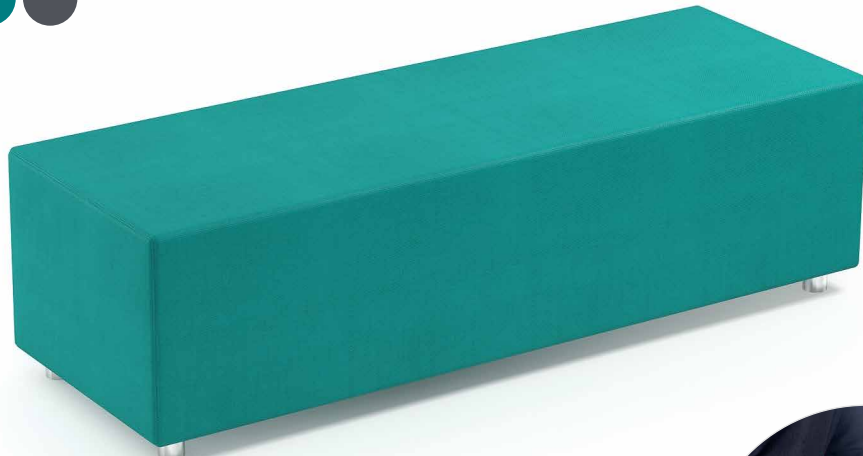
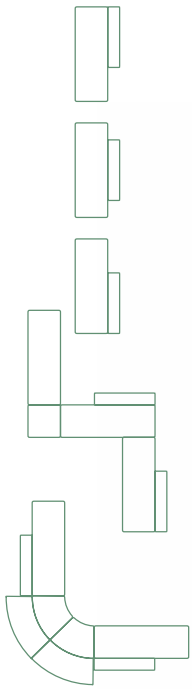

COMPLETE SOFA

Ref. 12005

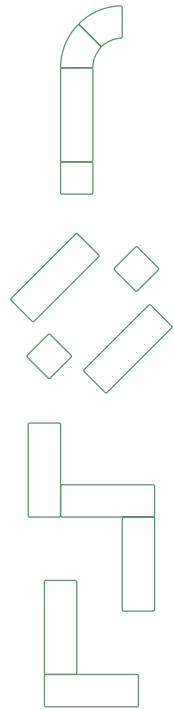

SIZE

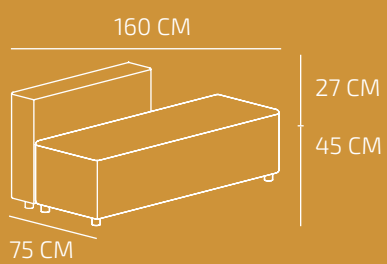

DETAILS





MOVE

Ref. 1608



Easy to move



SIZE

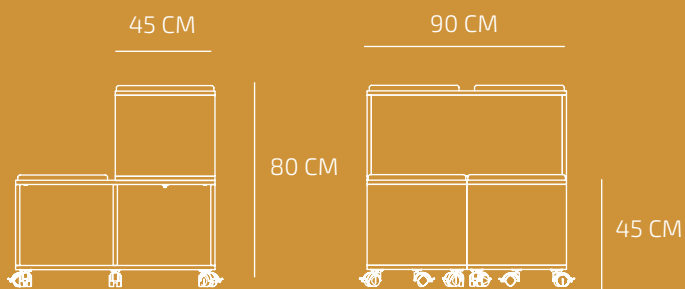

DETAILS



MINI MOVE

Ref. 1609



Easy to move



SIZE

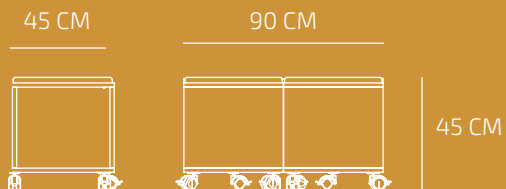

DETAILS



Tables

Work platforms. Tables that allow classrooms to be quickly configured and adapted for collaborative work. With height-adjustable, mobile, easy to fit and storable designs to quickly facilitate the execution of any task.

Plataformas de trabajo. Mesas que permiten configurar y adaptar las aulas ágilmente para el trabajo colaborativo. Con diseños ajustables en altura, móviles, encajables y almacenables para facilitar rápidamente la ejecución de cualquier tarea.

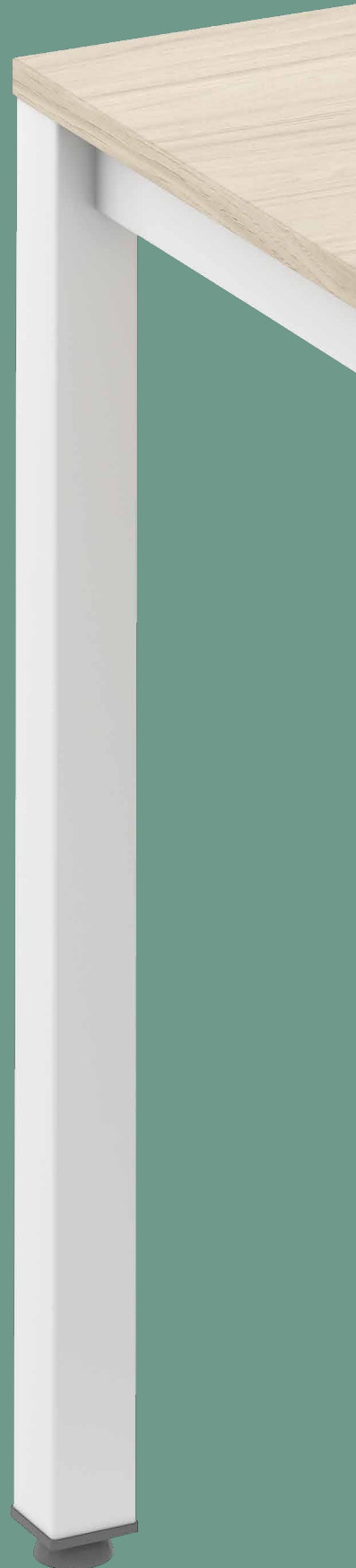



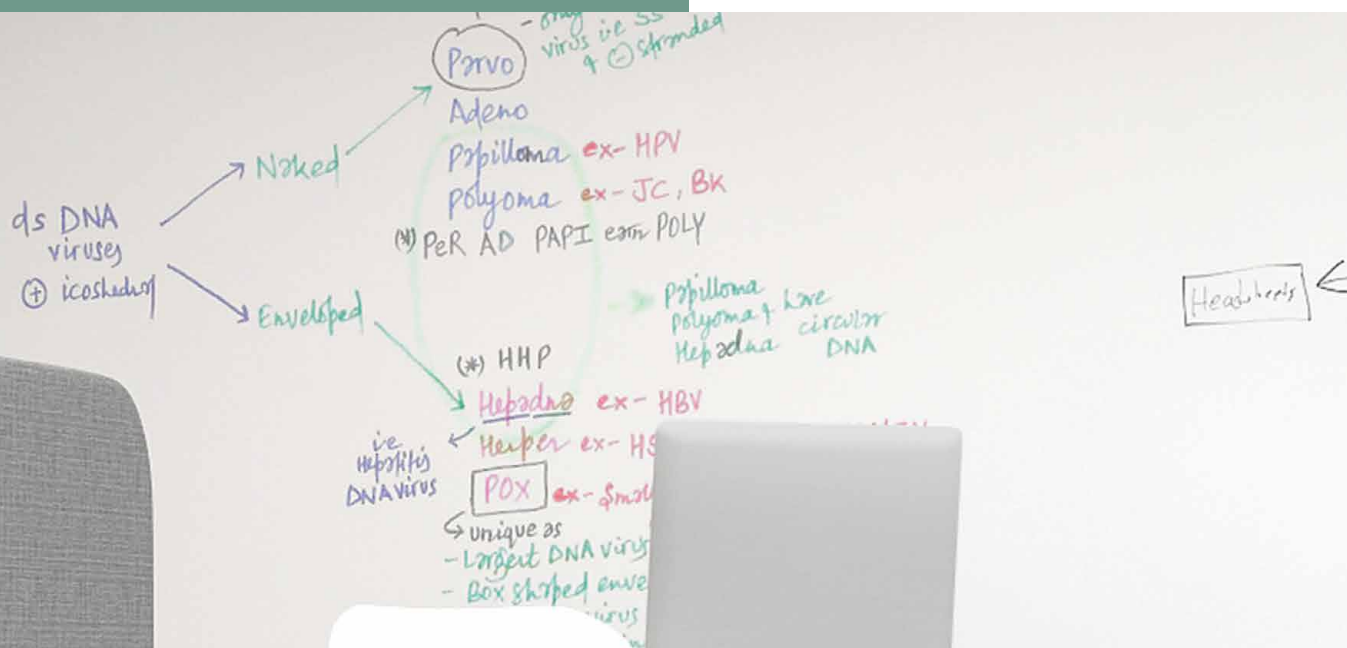

MOON

Ref. 2362



MAX.
H 102 cm



MIN.
H 73 cm



SIZE

(+info P. 193)

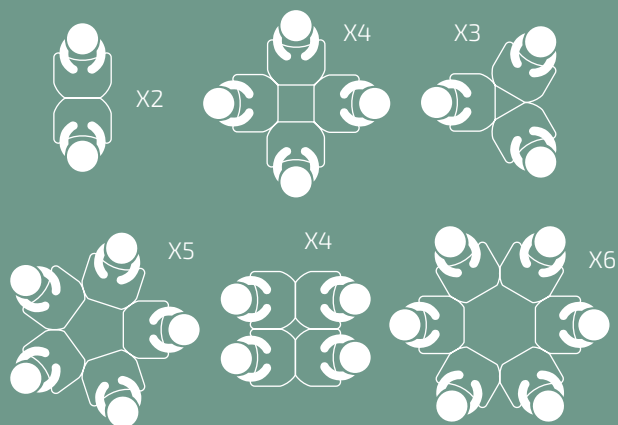

DETAILS





SQUARE

Ref. 2341IN



SIZE

(+info P. 193)



DISTRIBUTION

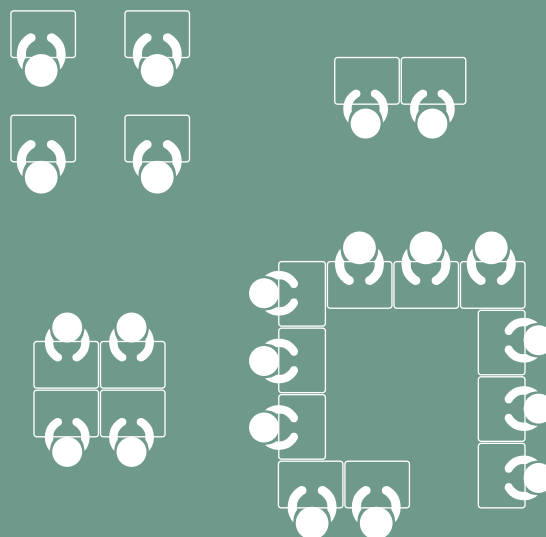

COMBINATIONS

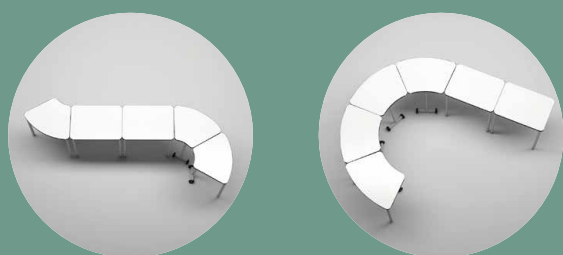

ARROW

Ref. 2329IN



Injected PP edge



SIZE

(+info P. 193)

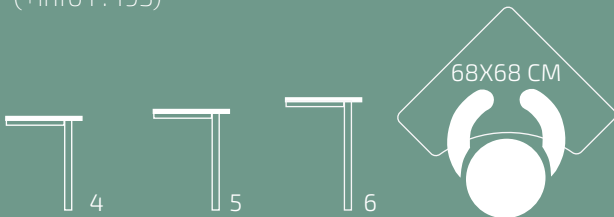

COMBINATIONS

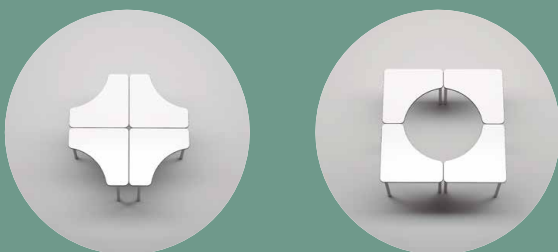

DISTRIBUTION

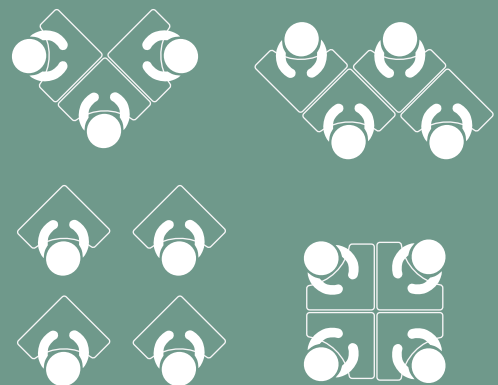



HEXA

Ref. 2336IN

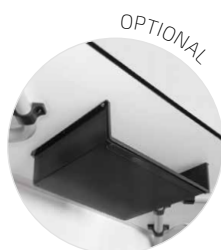

SIZE

(+info P. 193)

72X50 CM

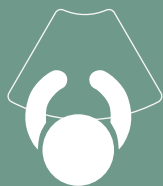

COMBINATIONS

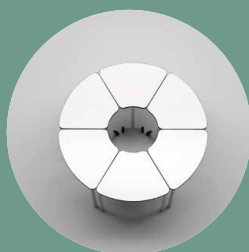

DISTRIBUTION



Ø 150 cm



OCTA

Ref. 2335IN

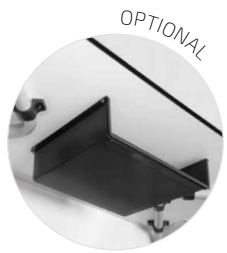

SIZE

(+info P. 193)



COMBINATIONS

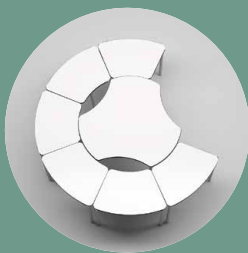

DISTRIBUTION



Ø 222 cm





YANG

Ref. 2345RC (1-3)
Ref. 2345R (4-6)



1-3



4-6

ABS edge



SIZE

(+info P. 193)



DISTRIBUTION

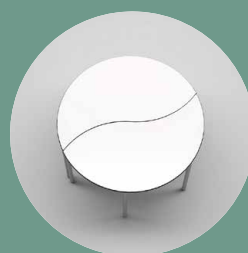
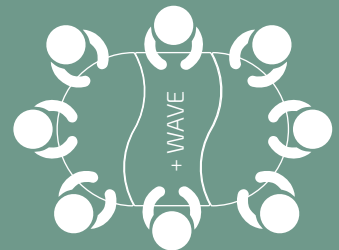
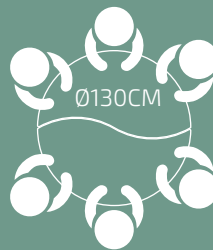

WAVE

Ref. 2344RC (1-3)
Ref. 2344R (4-6)



1-3



4-6

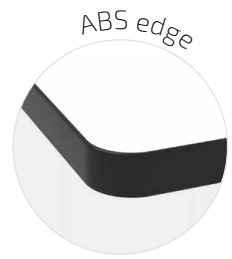

SIZE

(+info P. 193)



DISTRIBUTION

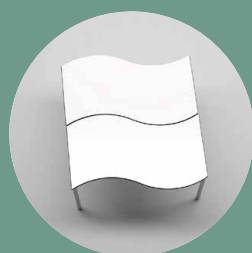
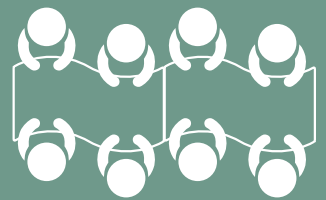
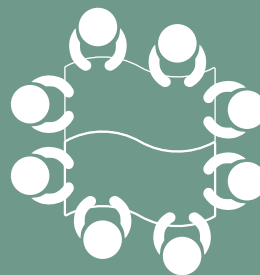



TRISIX

Ref. 2346RCIN (1-3)

Ref. 2346IN (4-6)



1-3



4-6

Injected PP edge



SIZE

(+info P. 193)



DISTRIBUTION

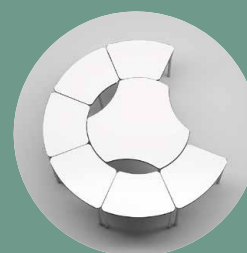
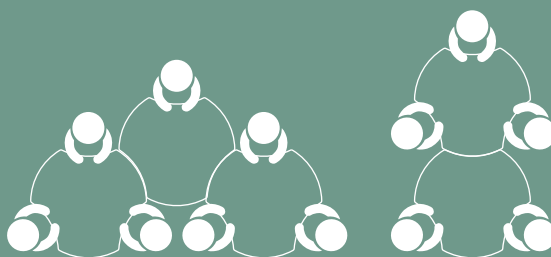





RECTANGLE

Ref. 2352-3 (1-3)
Ref. 2352-6 (4-6)



1-3



4-6

ABS edge



SIZE

(+info P. 193)



SIZE

(+info P. 189)



70X80 CM



120X80 CM



140X80 CM



RECTANGLE PLUS

Ref. 2353-8



ABS edge



SIZE

(+info P. 193)



120X65 CM



180X65 CM





RECTANGLE TEACHER

Ref. 2355D



SIZE (+info P. 193)

120X65 CM





NAXEL

Ref. 620

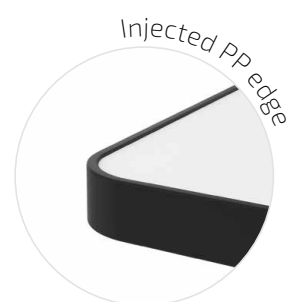

SIZE

(+info P. 193)



4



5



6

70X50 CM







SPACE DESIGN

Ref. 261



OPTIONS



SIZE

(+info P. 193)

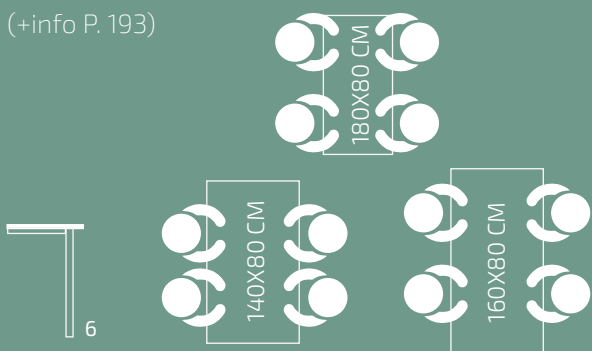

DETAILS



OPTIONS





SPACE PLUS

Ref. 260

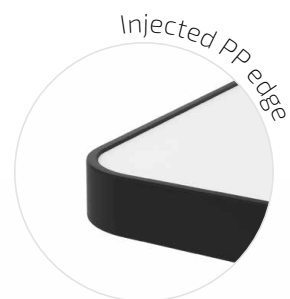

SIZE

(+info P. 193)



DETAILS







ALUFLOOP

Ref. 2048R

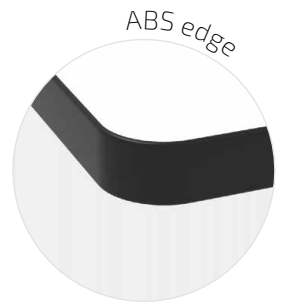

SIZE

(+info P. 193)

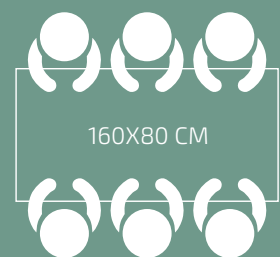
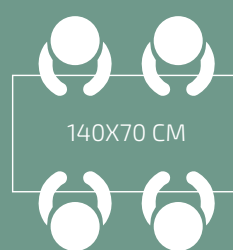
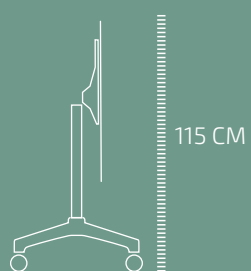
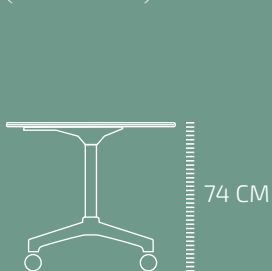

MINIFLOOP

Ref. 2261DNR

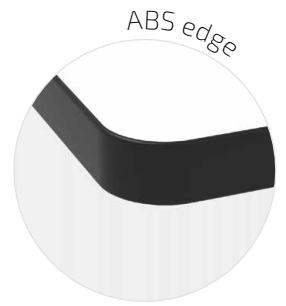

SIZE

(+info P. 193)

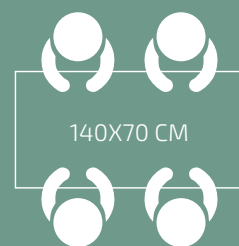
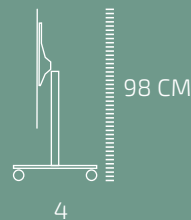
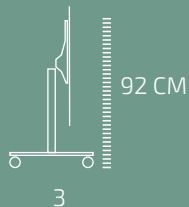
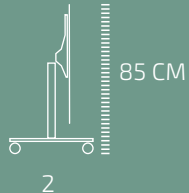
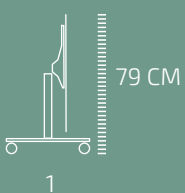



LOUISE

Ref. 2354



H 47 CM



H 70 CM



360°

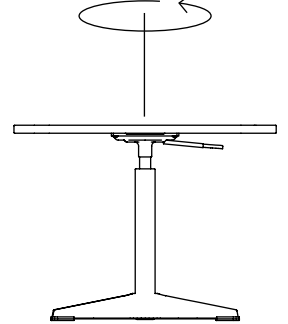

SIZE

(+info P. 193)

66 CM

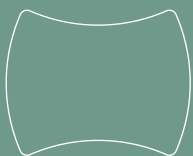

52 CM

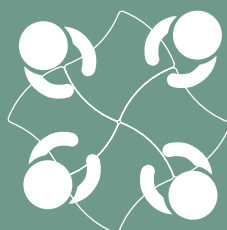

DETAILS





RONY

Ref. 2221 - 2220



SIZE

(+info P. 193)



OPTIONS

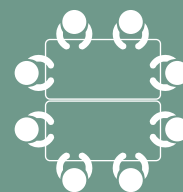
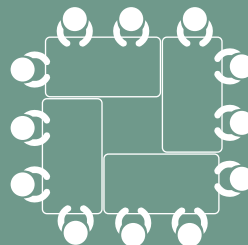
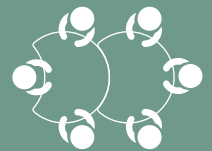
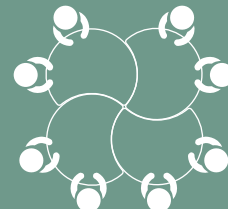
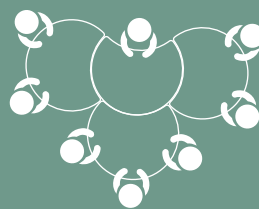





TEO

Ref. 2368



SIZE

(+info P. 193)



DETAILS



Acoustic

Making the classroom experience better. Acoustic panels and dividers absorb sound, reduce reverberation and improve intelligibility, well-being, concentration and speech performance in classrooms.

Mejorar la experiencia en el aula. Los paneles y separadores acústicos absorben el sonido, reducen la reverberación y mejoran la inteligibilidad, el bienestar, la concentración y el rendimiento del habla en las aulas.





VELVET CR

Ref. Velvet CR

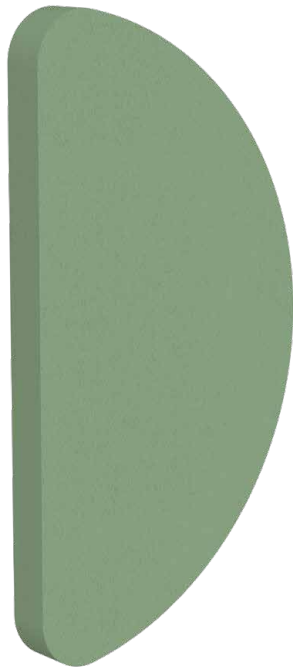

SIZE



DETAILS



VELVET RF

Ref. Velvet RF

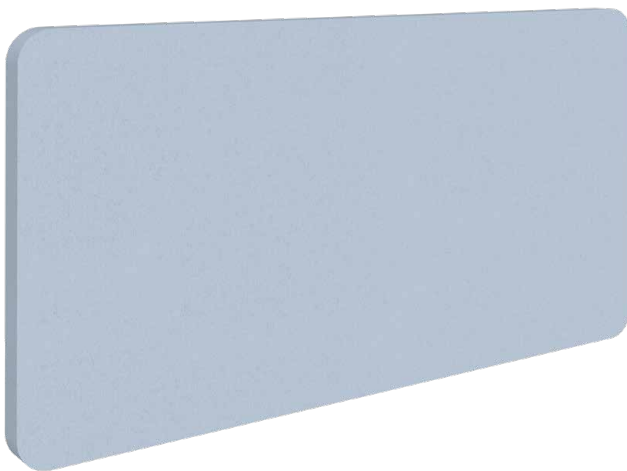

SIZE

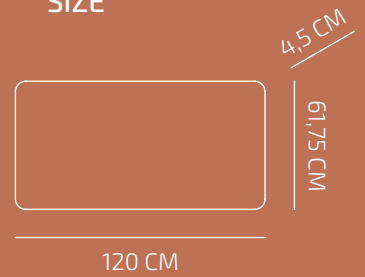

DETAILS





SIZE

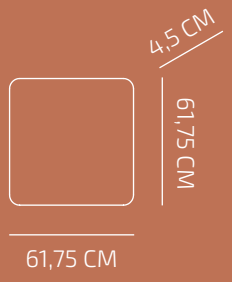

DETAILS

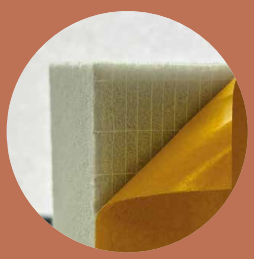

VELVET SQ

Ref. Velvet SQ



SIZE



DETAILS

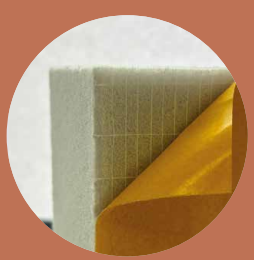

VELVET TR

Ref. Velvet TR





SAMOS

Ref. 2104

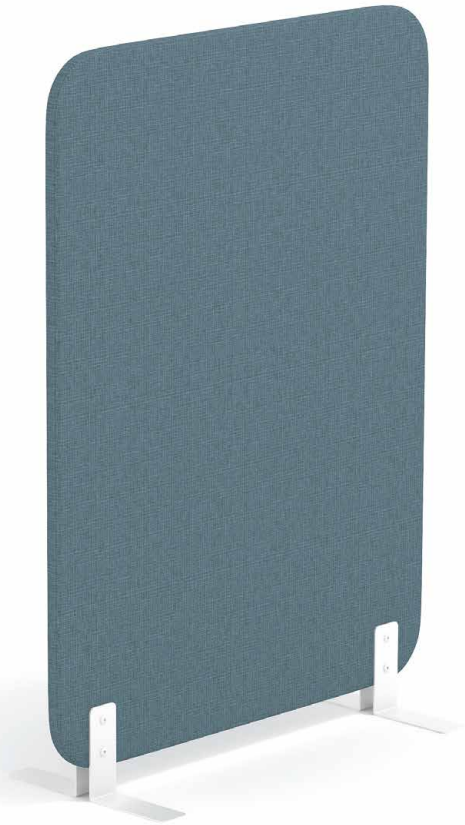

SIZE

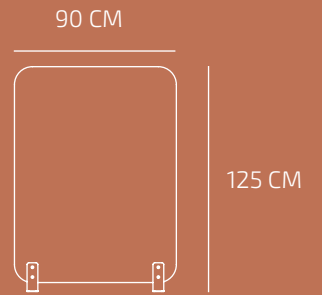

ELEA

Ref. 2105

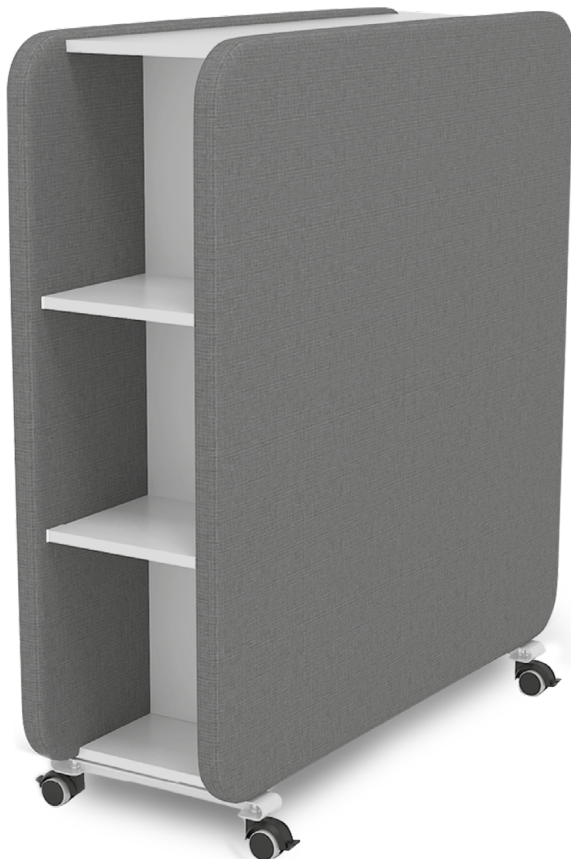

SIZE

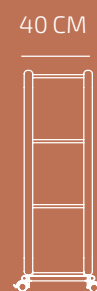
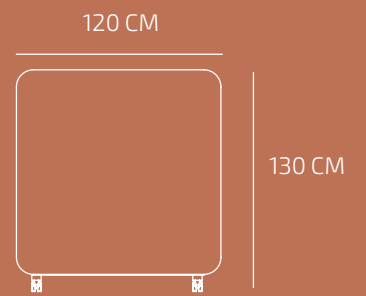



Cabinets

Everything in its place.

Each educational space and classroom have their specific requirements for learning material and distribution. Cabinets are a key element designed to facilitate the different dynamics and the order that each classroom needs.

Todo en su sitio.

Cada espacio educativo y cada aula tiene sus requerimientos específicos de material de aprendizaje y distribución. Los armarios son un elemento clave diseñado para facilitar las diferentes dinámicas y el orden que cada aula necesita.

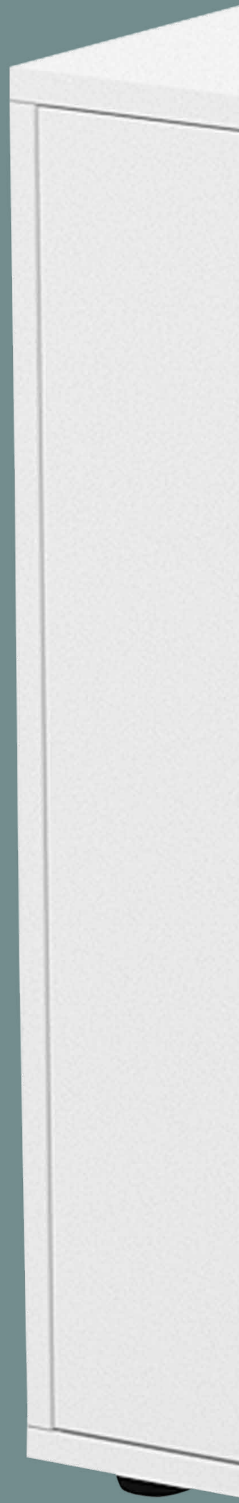





H 80cm



MARIE
Ref. 732-601



HEDY
Ref. 532-501



ADA
Ref. 532-502



JANE
Ref. 632-504

H 120cm



IRENE
Ref. 533-501



EMMY
Ref. 533-502



ANNIE
Ref. 633-507



SOPHIE
Ref. 633-501

H 160cm



MILEVA
Ref. 534-501



FLORA
Ref. 534-508



INGE
Ref. 534-509



ELSA
Ref. 634-508

H 200cm



EMILIE
Ref. 535-501



MAUD
Ref. 535-508



ROSIE
Ref. 535-521



MERIT

Ref. 632-507



GRACE

Ref. 632-501



ALICE

Ref. 634-510



DAN

Ref. 551

COLOURS



DETAILS



OPTIONS





MARIE

Ref. 732-601

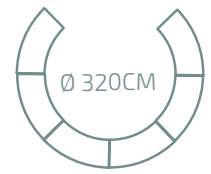

SIZE

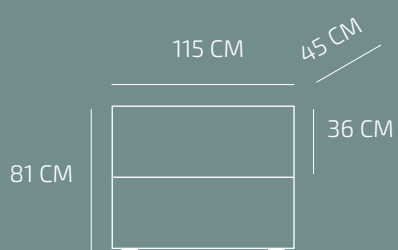

OPTIONS



COMBINATIONS



HEDY

Ref. 532-501



ADA

Ref. 532-501



SIZE

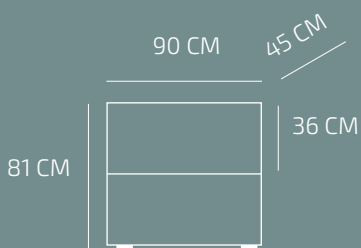

OPTIONS



DETAILS



JANE

Ref. 632-504



SIZE

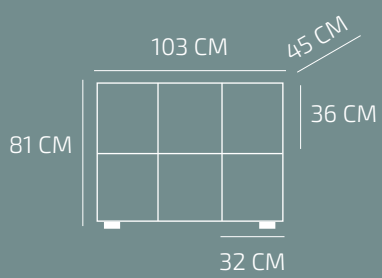

OPTIONS



MERIT

Ref. 632-507

Ref. 632-508



 x 9



 x 9



SIZE

Ref. 632-507

Ref. 632-508

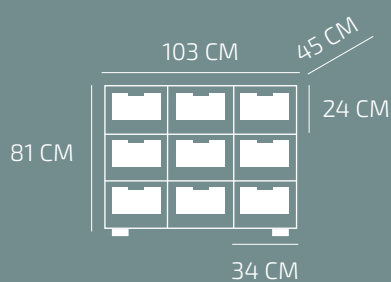
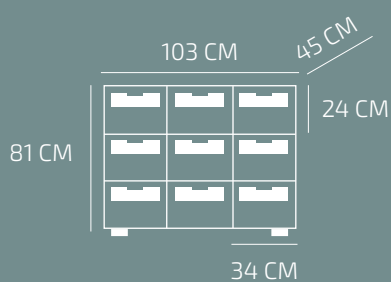

OPTIONS





GRACE

Ref. 632-501

Ref. 632-503



 x 21



 x 12



SIZE

Ref. 632-501

Ref. 632-503

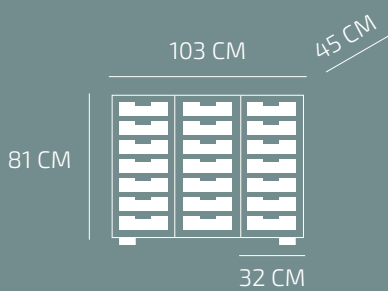

OPTIONS







IRENE

Ref. 533-501



EMMY

Ref. 533-502



SIZE

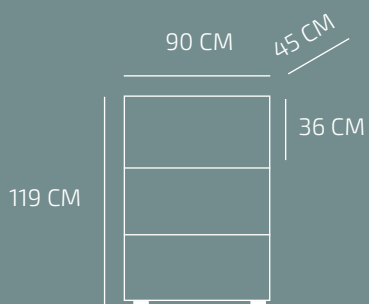

OPTIONS



DETAILS





ANNIE

Ref. 633-507

Ref. 633-509



 x15



 x15



SIZE

Ref. 633-507

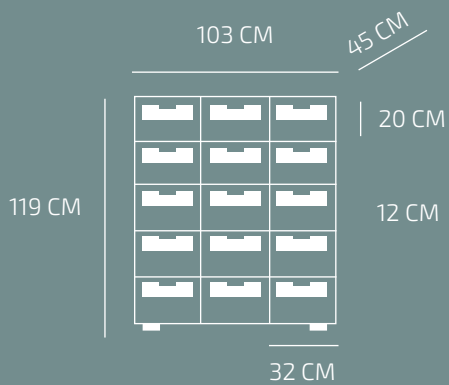

Ref. 633-509

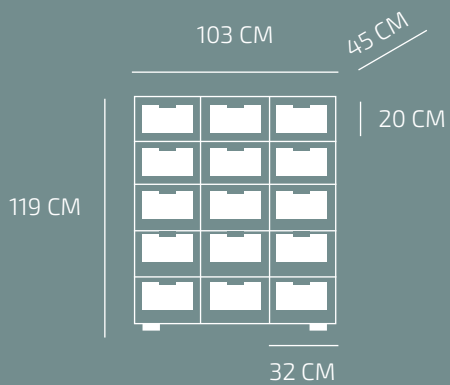

SOPHIE

Ref. 633-501

Ref. 633-503



 x33



 x 18



SIZE

Ref. 633-501

Ref. 633-503

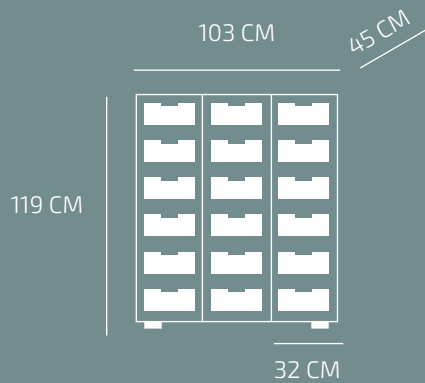
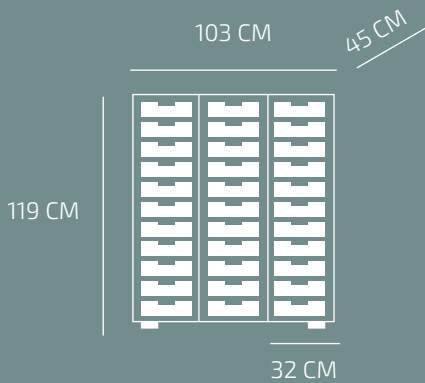

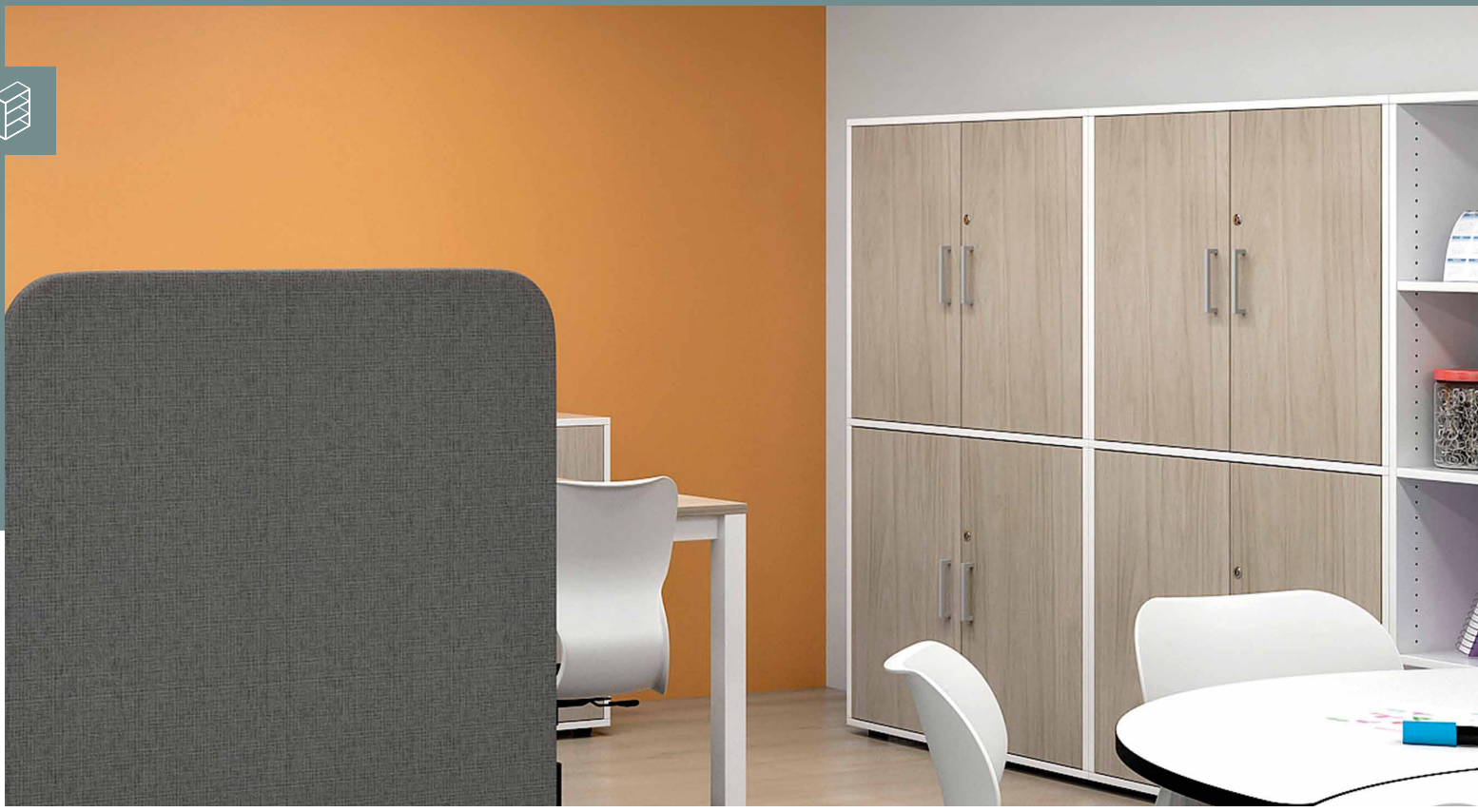

MILEVA

Ref. 534-501



FLORA

Ref. 534-508





INGE

Ref. 534-509



SIZE

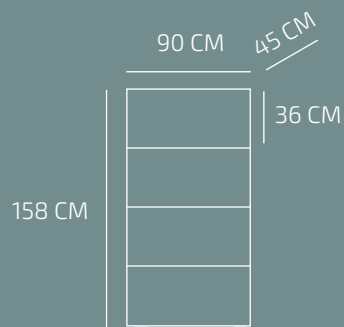

OPTIONS





ELSA

Ref. 634-508



SIZE

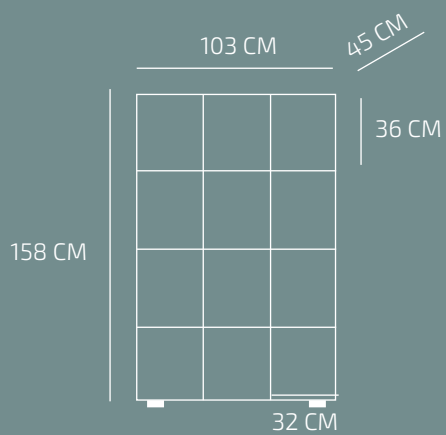

ALICE

Ref. 634-510

Ref. 634-512



 x 21



 x 12



SIZE

Ref. 634-510

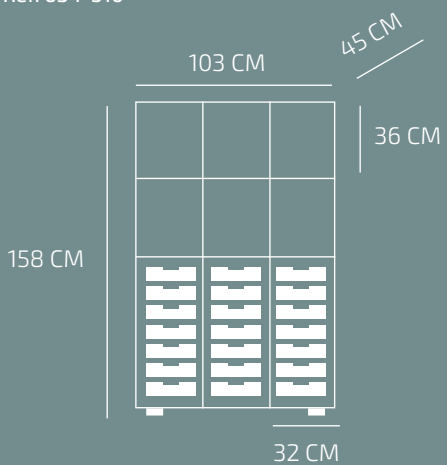

Ref. 634-512

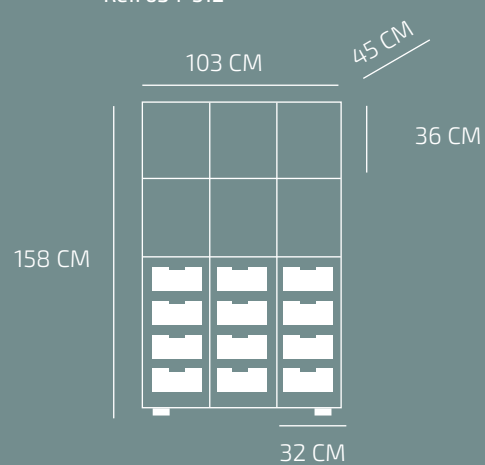



EMILIE

Ref. 535-501



MAUD

Ref. 535-508





ROSIE

Ref. 535-521



SIZE

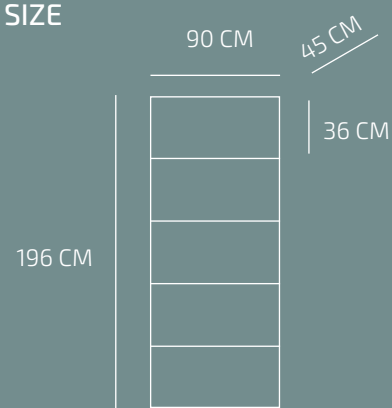

OPTIONS





DAN

Ref. 551



SIZE

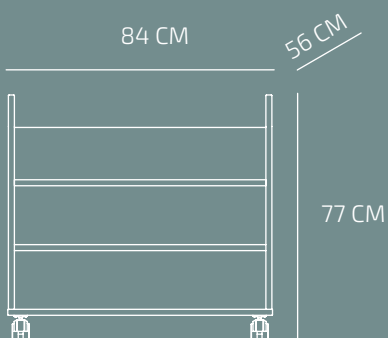

DETAILS





Complements

For a smoother experience.
Support tools designed to facilitate
collaborative learning dynamics and a fluid
and orderly cohabitation in the classroom.

Para una experiencia más fluida.
Herramientas de apoyo pensadas para facilitar
las dinámicas de aprendizaje colaborativo y
una fluida y ordenada convivencia en el aula.



CONNECTIONS

CONCEPTS

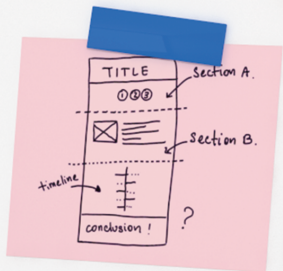
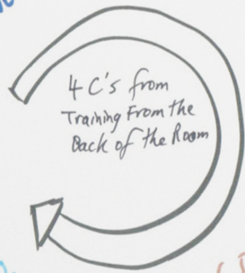

| NOVEMBRE | | | | | | |
|----------|----|----|----|----|----|----|
| SA | DM | DE | VE | VI | DI | DO |
| | 1 | 2 | 3 | 4 | 5 | 6 |
| 7 | 8 | 9 | 10 | 11 | 12 | 13 |
| 14 | 15 | 16 | 17 | 18 | 19 | 20 |
| 21 | 22 | 23 | 24 | 25 | 26 | 27 |
| 28 | 29 | 30 | | | | |

| MARS | | | | | | |
|------|----|----|----|----|----|----|
| SA | DM | DE | VE | VI | DI | DO |
| | 1 | 2 | 3 | 4 | 5 | |
| 6 | 7 | 8 | 9 | 10 | 11 | 12 |
| 13 | 14 | 15 | 16 | 17 | 18 | 19 |
| 20 | 21 | 22 | 23 | 24 | 25 | 26 |
| 27 | 28 | 29 | 30 | 31 | | |

KEY LEARNINGS

RELATE TO WORK

CONCLUSIONS

CONCRETE PRACTICE

→ Active Participation
→ Collaborative Interdependence

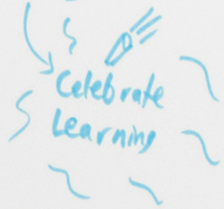



SIZE

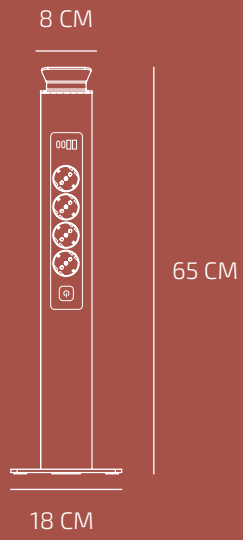

DETAILS



ODON



SIZE

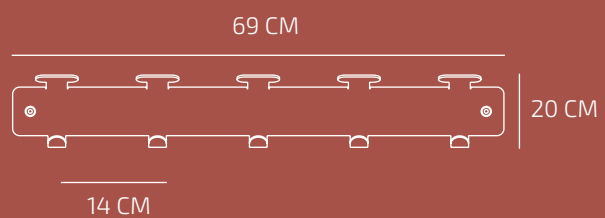

MARCUS

Ref. 7028

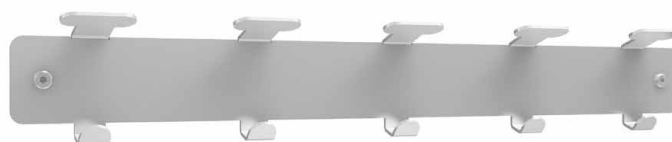

SIZE

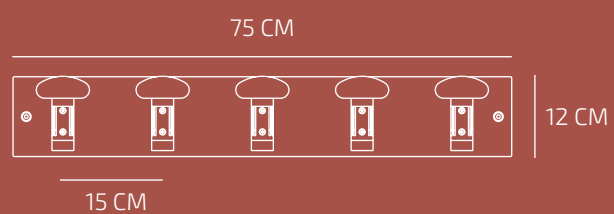

PEGGY

Ref. 751





LILY

Ref.4001



SIZE

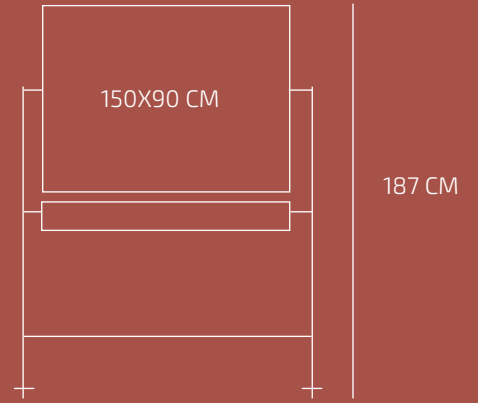

DETAILS



MINI LILY

Ref. 4002



Ref. 7029



SIZE

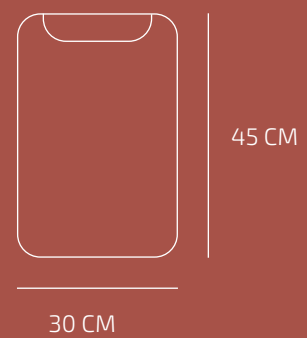



Classroom design service

mirplayschool.com

The team in Mirplay School helps you adapt your centre's learning spaces to the new educational dynamics taking place in it. Creating and optimising different spaces in a classroom, improving its acoustics and facilitating the orderly movement of students can be very easy.

With versatile furniture that is easy to move and store, comfortable and capable of coping with daily use, a wide range of possibilities opens up.

El equipo de Mirplay School te ayuda a adaptar los espacios de aprendizaje de tu centro a las nuevas dinámicas educativas que en él se suceden. Crear y optimizar diferentes espacios en un aula, mejorar su acústica y facilitar el movimiento ordenado de los alumnos puede ser muy sencillo.

Con mobiliario versátil, fácilmente desplazable y almacenable, de diseño cómodo y que absorba su uso diario, se abre un gran abanico de posibilidades.

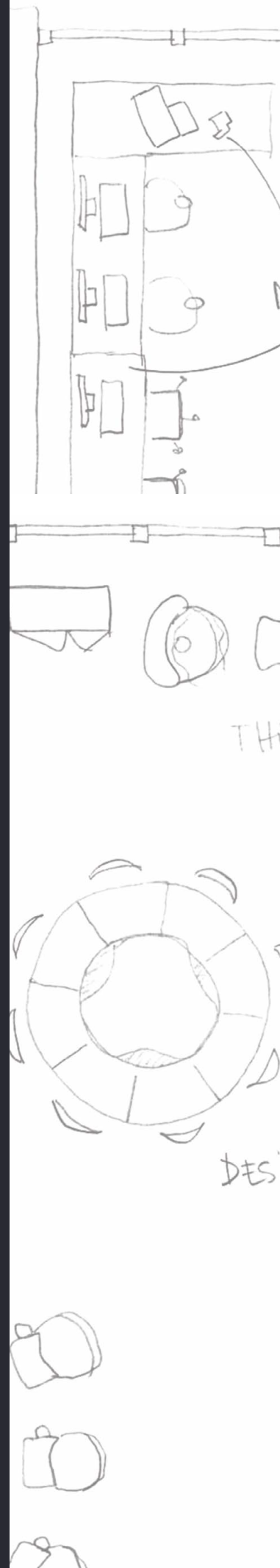

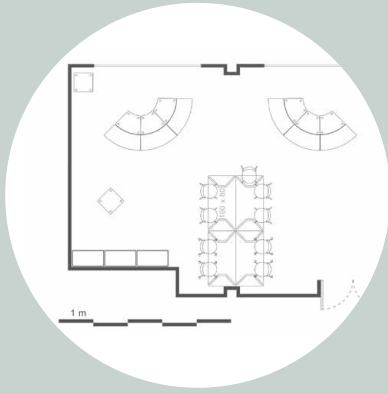

FLOOR LAYOUT DISTRIBUCIÓN EN PLANTA

We offer a proposal for the distribution of your space in a plan view, simple and easy to implement.

Te planteamos una propuesta de distribución de tu espacio en una vista en planta, sencilla y fácil de poner en práctica.



3D VIEWS OF YOUR SPACE VISTAS EN 3D DE TU ESPACIO

Do you want to visualize how it will look like? You just have to tell us what the space is like, what you want to achieve and we will make you a proposal in 3D image.

¿Quieres visualizar cómo quedará? Solo tienes que indicarnos cómo es el espacio, qué quieres conseguir y nosotros te hacemos una propuesta en imagen 3D.

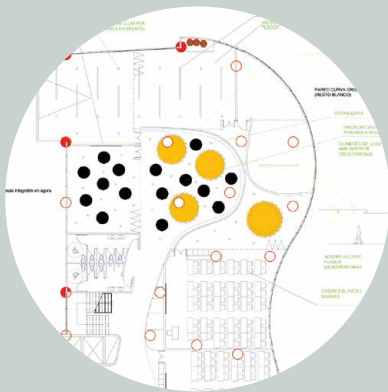

ARCHITECTURAL DRAFT ANTEPROYECTO ARQUITECTÓNICO

Our team of architects projects and adapts the space so that it supports and stimulates the activities that will take place in it.

Nuestro equipo de arquitectos proyecta y adapta el espacio para que sostenga y dinamice las actividades que en él tendrán lugar.



FURNISHING PROJECT PROYECTO DE DECORACIÓN

We guide you in interior design decisions to create a comprehensive decoration proposal.

Te acompañamos y guiamos en las decisiones de interiorismo para crear una propuesta integral de decoración.

JON
1045



p. 94

MIA BASIC
1028



p. 98

MIA CANTILEVER
1027



p. 99

MIA CASTORS
1029



p. 100

MIA MINI LIFT
169



p. 101

MIA LIFT
1035



p. 102

MIA BIG LIFT
1039



p. 103

MIA STOOL
1030



p. 104

MIA STORE
1038



p. 105

MIA TABLE
1036



p. 106

ZTOOL
1020



p. 108

ZTOOL TROLLEY
1037



p. 108

INA
1047



p. 111

ZOE
1044



p. 111

CHLOE



p. 114

CHARLOTTE
1041



p. 115

ANGLE
12001



p. 116

CUBE
12002



p. 116

TUBE
12003



p. 117

COMPLETE SOFA
12005

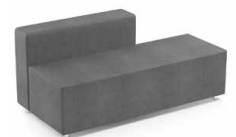

p. 117

MOVE
1608



p. 118

MINI MOVE
1609



p. 119

MOON
2362



p. 123

SQUARE
2341IN



p. 124

ARROW
2329IN



p. 125

HEXA
2336IN



p. 126

OCTA
2335IN



p. 127

YANG
2345R



p. 128

WAVE
2344R



p. 129

TRISIX
2346IN



p. 130

RECTANGLE
2352



p. 132

RECTANGLE PLUS
2353



p. 133

RECTANGLE TEACHER
2355D



p. 135

NAXEL
620



p. 136

SPACE DESIGN
261



p. 139

SPACE PLUS
260



p. 140

ALUFLOOP
2048R



p. 142

MINIFLOOP
226DNR



p. 143

LOUISE
2354



p. 145

RONY
2221



p. 146

RONY
2220



p.146

TEO
2368



p. 149

VELVET CR
VELVET CR

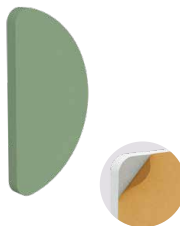

p. 152

VELVET RF
VELVET RF

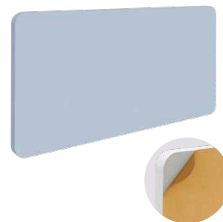

p. 152

VELVET SQ
VELVET SQ



p. 153

VELVET TR
VELVET TR



p. 153

SAMOS
2104



p. 154

ELEA
2105



p. 154

MARIE
732-601



p. 160

HEDY
532-501



p. 161

ADA
532-502



p. 161

JANE
632-504



p. 162

MERIT
632-507



p. 163

MERIT
632-508



p. 163

GRACE
632-501



p. 164

GRACE
632-503



p. 164

IRENE
533-501



p. 167

EMMY
533-502



p. 167

ANNIE
633-507



p. 168

ANNIE
633-509



p. 168

SOPHIE
633-501



p. 169

SOPHIE
633-503



p. 169

MILEVA
534-501



p. 170

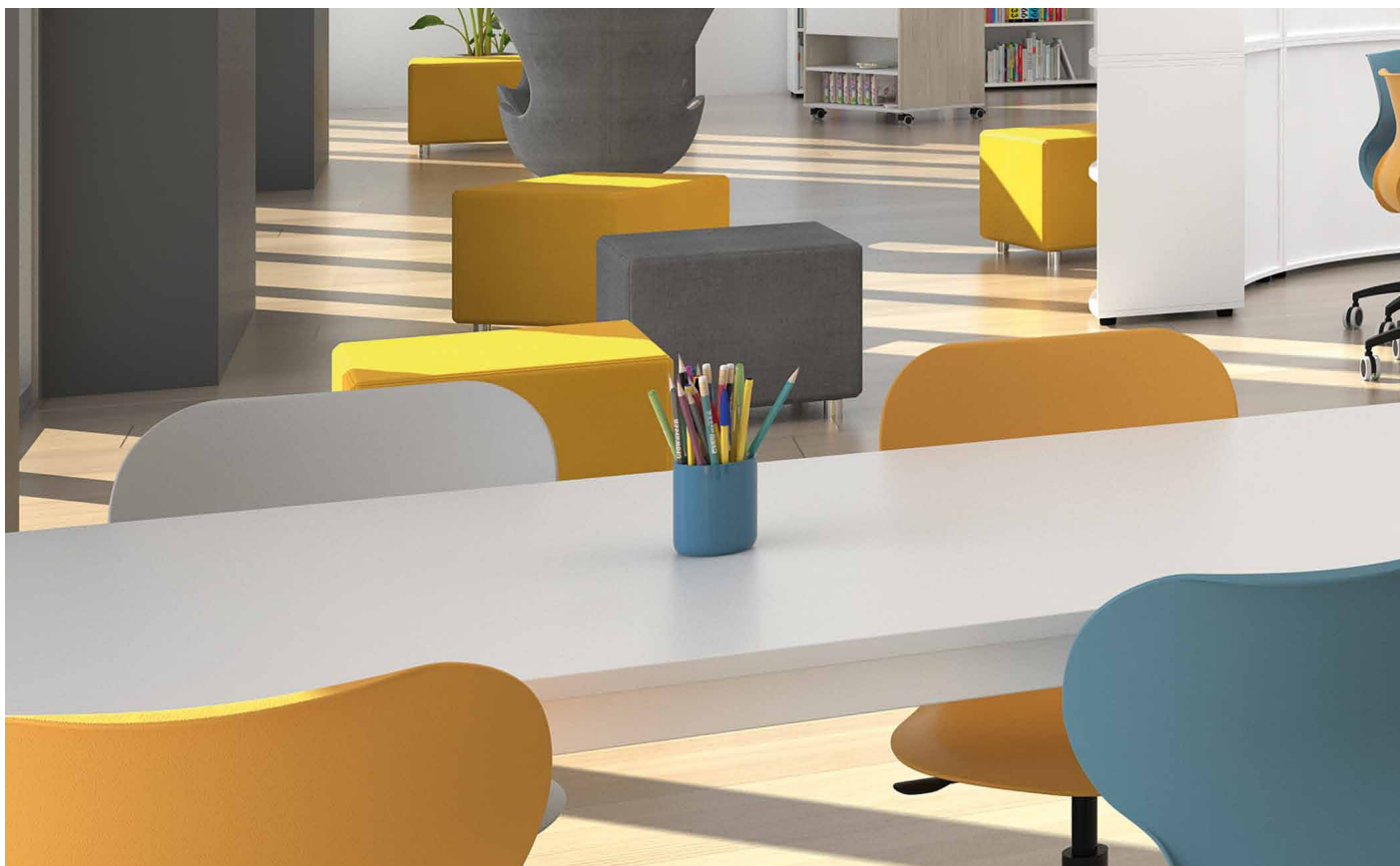

FLORA
534-508



p. 170

INGE
534-509



p. 171

ELSA
634-508



p. 172

ALICE
634-510



p. 173

ALICE
634-512



p. 173

EMILIE
535-501



p. 174

MAUD
535-508



p. 174

ROSIE
535-521



p. 175

DAN
551



p. 176

ODON



p. 180

MARCUS
7028



p. 181

PEGGY
751



p. 181

LILY
4001



p. 182

MINI LILY
4002



p. 182

MINI LILY HOOK
7029



p. 182



Size

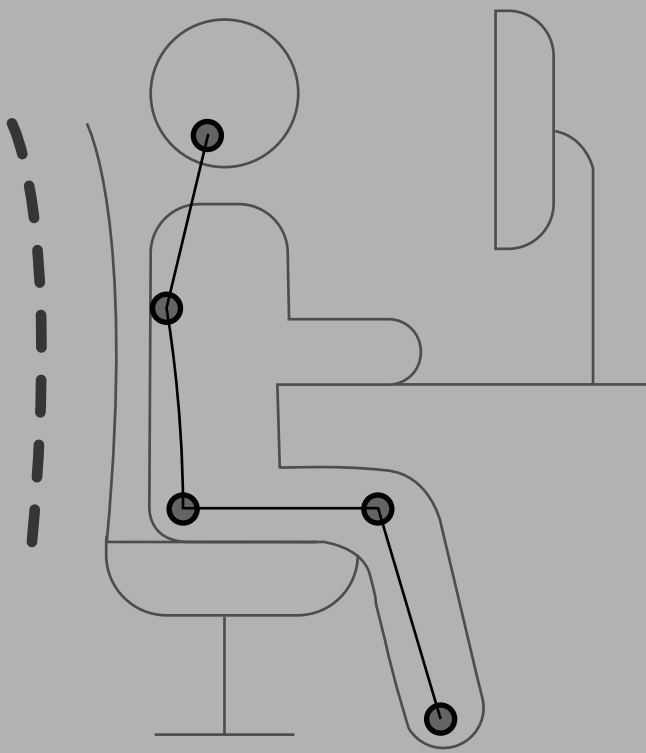

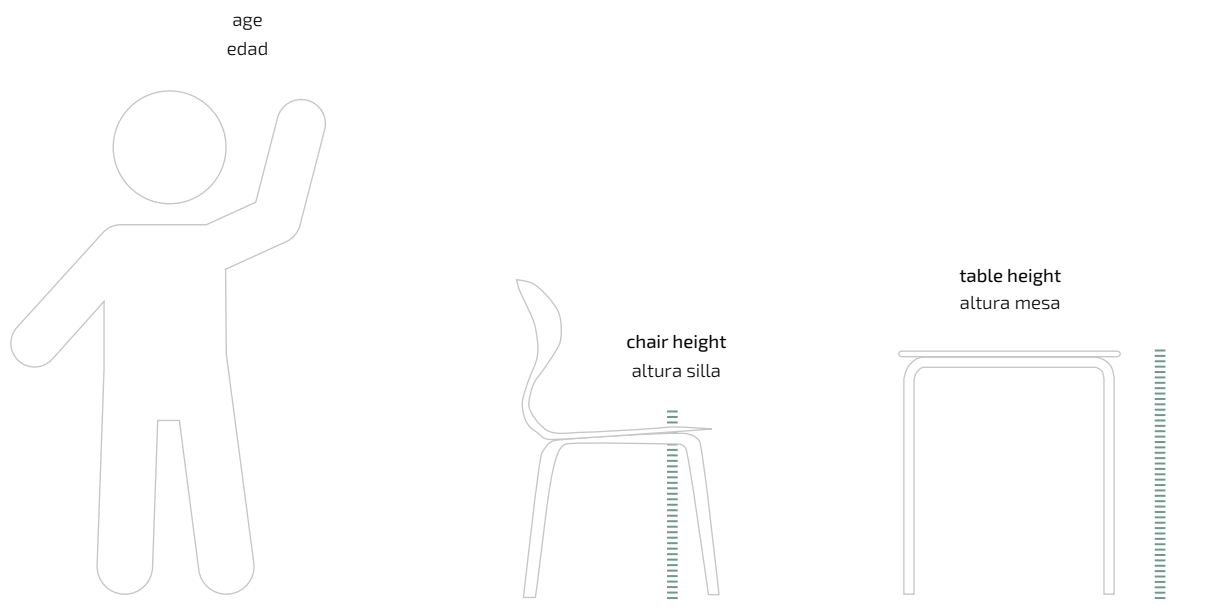

| SIZE TALLA | AGE EDAD | CHAIR HEIGHT ALTURA ASIENTO | TABLE HEIGHT ALTURA MESA |
|---------------|-------------|--------------------------------|-----------------------------|
| 0 | 1-2 | 21 cm | 40 cm |
| 1 | 2-3 | 26 cm | 46 cm |
| 2 | 3-4 | 30 cm | 52 cm |
| 3 | 4-6 | 34 cm | 59 cm |
| 4 | 6-8 | 38 cm | 65 cm |
| 5 | 8-10 | 42 cm | 70 cm |
| 6 | +12 | 46 cm | 77 cm |
| 8* | +8 | 80 cm | 100 cm |

Size according to European regulation UNE EN 1729-1: 07 / UNE EN 1729-2: 07.
Tallas según la normativa europea UNE EN 1729-1: 07 / UNE EN 1729-2: 07.

*Equivalence UNE-EN 1729-1 size 5 dimensions for tables to work standing up.

*Equivalencia UNE-EN 1729-1 a dimensiones talla 5 para mesas de trabajo de pie.

Our products are designed and manufactured according to the corresponding implementation regulations:

Chairs and tables for educational institutions.

UNE EN 1729-1: 2016 / UNE EN 1729-2: 2012.

Dimensions, safety requirements and test methods.

UNE-EN 71-3: 2019 - Migration of certain elements.

Mirplay certifies its products in European laboratories SGS.

Nuestros productos están diseñados y fabricados según las normativas de aplicación correspondientes. Relación de normas aplicables:

Sillas y mesas para centros educativos.

UNE EN 1729-1: 2016 / UNE EN 1729-2: 2012.

Dimensiones, requisitos de seguridad y métodos de ensayo.

UNE - EN 71-3: 2019 - Migración de ciertos elementos.

Mirplay certifica sus productos en el laboratorio de referencia internacional SGS.



- * Minimum of 60% post-consumer recycled plastic
- * Mínimo 60% de plástico reciclado post-consumer



The catalogue's images have not a contractual value. They are illustrative and they cannot correspond exactly with the product. The images shown in this catalogue are property of Mobles Mir i Equipaments, its reproduction, distribution, public communication and transformation are forbidden without authorization.

Las imágenes de este catálogo no tienen un valor contractual. Son ilustrativas y podrían no corresponder exactamente al producto. Las imágenes que aparecen en este catálogo son propiedad de Mobles Mir i Equipaments, queda prohibida su reproducción, distribución, comunicación pública y transformación, sin autorización.



Mirplay[®]

school



mirplayschool.com

HEADQUARTERS

BP-4313 - Punt Km 28,7
08279 Avinyó · BCN · SPAIN

+34 938 124 452
info@mirplayschool.com

Designed by Mirplay 2024

MIRPLAY MÉXICO
mexico@mirplay.com

MIRPLAY UK
uk@mirplay.com

MIRPLAY ASIA
asia@mirplay.com

#Neverstopplaying
#Neverstoplearning